CHAPTER 4

CONVEYANCE SYSTEM ANALYSIS & DESIGN



CITY OF RENTON

SURFACE WATER DESIGN MANUAL

Section	Page
4.1 Route Design and Easement Requirements	4-3
4.1.1 Route Design	4-3
4.1.2 Easement and Setback Requirements	4-3
4.2 Pipes, Outfalls, and Pumps	4-7
4.2.1 Pipe Systems	4-7
4.2.2 Outfall Systems	4-30
4.2.3 Pump Systems	4-36
4.3 Culverts and Bridges	4-37
4.3.1 Culverts	4-37
4.3.2 Culverts Providing for Fish Passage/Migration	4-50
4.3.3 Bridges	4-52
4.4 Open Channels, Floodplains, and Floodways	4-55
4.4.1 Open Channels	4-55
4.4.2 Floodplain/Floodway Analysis	4-71

(This page intentionally left blank.)

CHAPTER 4

CONVEYANCE SYSTEM ANALYSIS & DESIGN

This chapter presents the City of Renton’s approved methods for the hydraulic analysis and design of conveyance systems. A *conveyance system* includes all portions of the surface water system, either natural or man-made, that transports surface and storm water runoff.

This chapter contains the detailed design criteria, methods of analysis, and schematic representations for all components of the conveyance system. In some cases, reference is made to other adopted or accepted design standards and criteria such as the *City of Renton Standard Details* and the requirements of the City of Renton Transportation department and Surface Water Utility as applicable.

The figures included in this chapter are provided as schematic representations and should not be used for design. Refer to the *City of Renton Standard Details* for specific design information. The figures provided in this chapter illustrate **one example** of how the conveyance system design criteria may be applied. Although the figures are meant to illustrate many of the most important design criteria, they may not show **all** criteria that apply. In general, the figures are not used to specify requirements unless they are indicated elsewhere in this manual. If this manual refers to a standard detail not included in the *City of Renton Standard Details*, the applicant shall use the figure provided in this manual.

Chapter Organization

The information presented in this chapter is organized into four main sections:

- Section 4.1, “Route Design and Easement Requirements”
- Section 4.2, “Pipes, Outfalls, and Pumps”
- Section 4.3, “Culverts and Bridges”
- Section 4.4, “Open Channels, Floodplains, and Floodways”

These sections begin on odd pages so the user can insert tabs if desired for quicker reference.

Required vs. Recommended Design Criteria

Both required and recommended design criteria are presented in this chapter. Criteria stated using “shall” or “must” are mandatory, to be followed unless there is a good reason to deviate as allowed by the adjustment process (see Section 1.4). These criteria are **required design criteria** and generally affect facility performance or critical *maintenance* factors.

Sometimes options are stated as part of the required design criteria using the language “should” or “may.” These criteria are **recommended design criteria**, but are closely related to the required criteria, so they are placed in the same section.

(This page intentionally left blank)

4.1 ROUTE DESIGN AND EASEMENT REQUIREMENTS

This section presents the general requirements for aligning conveyance systems and providing easements and setbacks to allow for proper *maintenance* and inspection of all conveyance system elements.

4.1.1 ROUTE DESIGN

The most efficient route selected for new conveyance systems will result from careful consideration of the topography of the area to be traversed, the legal property boundaries, and access for inspection and *maintenance*. Additionally, topography and native soil characteristics beneficial to *Low Impact Development (LID)* applications may influence the route. The general requirements for route design are as follows:

1. Proposed new conveyance systems should be aligned to **emulate the natural conveyance system** to the extent feasible. Inflow to the system and discharge from the system should occur at the natural drainage points as determined by topography and existing drainage patterns.
2. New conveyance system alignments in **residential subdivisions** should be located **adjacent and parallel to property lines** so that required drainage easements can be situated along property lines. Drainage easements should be located entirely on one property and not split between adjacent properties.
Exception: Streams and natural drainage channels shall not be relocated to meet this requirement.
3. Aesthetic considerations, traffic routes and *on-site BMP* strategies may dictate the placement and **alignment of open channels**. Appropriate vehicular and pedestrian traffic crossings must be provided in the design.
4. For any reach or partial reach of new conveyance (ditch, channel or closed pipe system) proposed by a *project*, a geotechnical analysis and report is required if the conveyance is located within 200 feet of a *steep slope hazard area* or *landslide hazard area*, OR if the conveyance is located within a setback distance from top of slope equal to the total vertical height of the slope area that is steeper than 15%. The geotechnical analysis must consider cumulative impacts from the *project* and surrounding areas under full built-out conditions. A low-permeability liner per Section 6.2.4 for the trench or channel may be required if warranted by soil stability conditions.

4.1.2 EASEMENT AND SETBACK REQUIREMENTS

Proposed *projects* must comply with the following easement and setback requirements unless otherwise approved by the City:

1. Any *onsite* conveyance system element (including *on-site BMPs* used as conveyance) constructed as part of a **subdivision project** shall be located in a dedicated drainage easement, tract, or right-of-way that preserves the system's route and conveyance capacity as follows:
 - *Onsite* conveyance systems within the right-of-way will be inspected and maintained by the City.
 - *Onsite* conveyance systems within the drainage easements or tracts will be maintained by the property owners through the Homeowners Association created by the subdivision (with each property owner having equal responsibility for *maintenance*). These conveyance elements include those entering and exiting the tract from/to the public right-of-way. For conveyance pipes entering the tract from right-of-way, responsibility begins at the last *structure* prior to entering the tract. For conveyance pipes exiting the tract to right-of-way, responsibility ends at the next downstream *structure*. The easement shall grant the City rights for inspection.

Exception: Roof downspout, minor yard, and footing drains do not require easements, tracts, or right-of-way. If easements are provided for these minor drains (or for other utilities such as power, gas or telephone), they need not comply with the requirements of this section.

*Note: except for those facilities that have been formally accepted for **maintenance** by the City, **maintenance** and repair of drainage facilities and BMPs on private property is the responsibility of the property owner. Except for the inflow pipe and discharge pipe of a City-accepted flow control or water quality facility, the City does not normally accept **maintenance** of conveyance systems constructed through private property.*

2. Any **onsite** conveyance system element (including **on-site BMPs** used as conveyance) constructed under a **commercial building or commercial development permit** shall be covered by the drainage facility declaration of covenant and grant of easement in Reference Section 8-J (or equivalent) that provides the City right of access for inspection, **maintenance**, and repair.

*Note: except for those facilities that have been formally accepted for **maintenance** by the City, **maintenance** and repair of drainage facilities on private property is the responsibility of the property owner.*

3. Retained or replaced 12-inch or greater pipe diameter (or equivalent) conveyance system elements that convey **offsite** flows on a **project site** on private property shall be covered by the drainage facility declaration of covenant and grant of easement in Reference Section 8-J (or equivalent) that provides the City right of access for inspection, **maintenance**, and repair. For **projects** with conveyance system elements as described above that cannot meet or be relocated to meet the easement and **building setback line (BSBL)** requirements in Table 4.1 due to the presence of existing **structures**, applicants are required only to record a notice on title that identifies the subject conveyance elements and states that **maintenance** and repair of those elements is the responsibility of the property owner. For conveyance system elements as described above that are on a **site** but not within the **project site**, applicants are required only to record a notice on title that identifies the subject conveyance elements and states that **maintenance** and repair of those elements is the responsibility of the property owner.

*Note: except for those facilities that have been formally accepted for **maintenance** by the City, **maintenance** and repair of drainage facilities on private property is the responsibility of the property owner.*

4. Any **offsite** conveyance system element (including **on-site BMPs** used as conveyance) constructed through private property as part of a proposed **project** that conveys runoff from public roads within the **project site** shall be located in a drainage easement dedicated to the City. If an **offsite** conveyance system through private property is proposed by a **project** to convey runoff diverted from the **natural discharge location**, the City may require a drainage release covenant per Reference Section 8-K as a condition of approval of the adjustment required in Section 1.2.1.
5. A **river protection easement** shall be required for all properties adjoining or including *major rivers*¹ that may be dedicated to the City or County as applicable. The County shall review and approve river protection easements dedicated to the County.
6. Table 4.1 lists the required **widths and BSBLs for drainage easements**. For all pipes or any channels or constructed swales greater than 30 feet wide, facilities must be placed in the center of the easement. For channels or constructed swales less than or equal to 30 feet wide, the easement extends to only one side of the facility.

*Note: The requirement for drainage easements with accompanying widths and **BSBLs** per Table 4.1 also applies to existing and replaced conveyance elements as described in #3 above.*

¹ *Major rivers* are defined in the King County Flood Hazard Management Plan.

7. Any portion of a conveyance system drainage easement (shown in Table 4.1) shall not be located within an **adjacent property or right-of-way**. Building setback lines may cross into adjacent property.
8. The distance between the easement line and building or other **structure** footings shall be no less than the **BSBL** distance shown in Table 4.1.

Exception: The BSBL distance indicated in Table 4.1 may be measured from the edge of a pipe in the easement plus 2 feet if all of the following conditions are met:

- As-builts showing the location of the pipe are submitted
- A geotechnical/**structure** analysis demonstrates stability of the proposed **structure**
- Access for **maintenance**/replacement remains unobstructed.

TABLE 4.1 EASEMENT WIDTHS AND BUILDING SETBACK LINES		
For Pipes:⁽¹⁾ Inside Diameter (ID)	Easement Width	BSBL (From Easement)
ID ≤ 36"	depth to invert < 8': 10 feet ⁽²⁾ depth to invert > 8': 15 feet	5 feet
36" < ID ≤ 60"	depth to invert < 8': 10 feet ⁽²⁾ depth to invert > 8': 15 feet	7.5 feet
ID > 60"	ID plus 10 feet	10 feet
For Channels and Swales: Top Width of Channel (W)	Easement Width	BSBL (From Easement)
W ≤ 10 feet	W plus 10 feet on one side W if no access required ⁽³⁾	5 feet
10 feet < W ≤ 30 feet	W plus 15 feet on one side	5 feet
W > 30 feet	W plus 15 feet on both sides	5 feet
For Major Rivers	Easement Width	BSBL (From Easement)
See the <i>King County Flood Hazard Management Plan</i> for a list of the major rivers	Varies per site conditions Minimum 30 feet from stable top of bank ⁽⁴⁾	5 feet
Notes:		
(1) Pipes installed deeper than 10 feet require one of the following actions: <ul style="list-style-type: none"> Increase the BSBL such that the distance from the BSBL to the centerline of the pipe is at least 1.5 times the depth to pipe invert, or Place a restriction on adjacent lots that the footings be placed at a specific elevation, deep enough that the closest horizontal distance from the footing to the pipe centerline is 1.5 times the difference in elevation of the footing and pipe invert, or Place a restriction on adjacent lots that the footings be designed by a geotechnical engineer or licensed engineering geologist, such that excavation of the pipe may be performed without necessitating shoring of adjacent structures. 		
(2) Fifteen-foot easement width is required for maintenance access to all manholes, inlets, and culverts.		
(3) Access is not required for small channels if the channel gradient is greater than 5% (assumes steep channels will be self-cleaning).		
(4) Stable top of bank shall be as determined by King County.		

(This page intentionally left blank.)

4.2 PIPES, OUTFALLS, AND PUMPS

This section presents the methods, criteria, and schematic representations for analysis and design of pipe systems, outfalls, and pump-dependent conveyance systems. The information presented is organized as follows:

- Section 4.2.1, “Pipe Systems”
 - “Design Criteria,” Section 4.2.1.1
 - “Methods of Analysis,” Section 4.2.1.2
- Section 4.2.2, “Outfall Systems”
 - “Design Criteria,” Section 4.2.2.1
- Section 4.2.3, “Pump Systems”
 - “Design Criteria,” Section 4.2.3.1
 - “Methods of Analysis,” Section 4.2.3.2.

4.2.1 PIPE SYSTEMS

Pipe systems are networks of storm drain pipes, catch basins, manholes, inlets, and outfalls designed and constructed to convey surface water. The hydraulic analysis of flow in storm drain pipes typically is limited to gravity flow; however, in analyzing existing systems it may be necessary to address pressurized conditions. A properly designed pipe system will maximize hydraulic efficiency by utilizing proper material, slope, and pipe size.

4.2.1.1 DESIGN CRITERIA

General

In addition to the design criteria described below, pipe systems shall be design to meet the hydraulic criteria as described in Section 1.2.4.1. These criteria supersede the methodology descriptions contained in Chapter 4.

All pipe material, joints, protective treatment, construction workmanship, and inspection requirements shall be in accordance with the *City of Renton Standard Details* and the requirements of the City of Renton Transportation Department of Surface Water Utility as applicable.

Note: The pipe materials and specifications included in this section are for conveyance systems installed according to engineering plans required for City permits/approvals. Other pipe materials and specifications may be used by private property owners for drainage systems they construct and maintain when such systems are not required by or granted to City.

Acceptable Pipe Sizes and Length Between Structures

Acceptable pipe sizes and maximum lengths between *structures* shall be per Table 4.2.1.A1.

TABLE 4.2.1.A1 PIPE SIZES AND LENGTHS BETWEEN STRUCTURES			
Upstream Structure to Downstream Structure	Pipe Diameter (in)	Where Allowed	Maximum Length (ft)
Inlet to CB/MH	8	Private	40
	12	Private	60
CB/MH to CB/MH	8	Private/Public ⁽¹⁾	100/66 ⁽¹⁾
	12 or greater	Private/Public	300 ⁽²⁾
Notes: (1) Minimum diameter for public pipes shall be 12 inches. However, 8-inch diameter public pipes may be permitted on cross street laterals less than 66 feet to avoid utility conflicts or to meet shallow grade. (2) Maximum spacing on surface drainage course between catch basins or manholes shall be 150 on grades less than 1% and 200 feet on grades from 1% to 3%. Otherwise, maximum spacing shall be 300 feet on grades over 3%, or as required by grate flow capacities. Maximum spacing may need to be reduced depending on street width and inlet capacity analysis in Section 4.2.1.2.			

Allowable Pipe Materials and Minimum Cover Requirements

- The designer shall have the option of constructing storm sewers, drains and culverts of the pipe types listed below within the cover limits specified. In addition, concrete pipe shall be rubber gasketed and metal pipe shall be gasketed and securely banded. Leak testing shall be conducted if required by the City Engineer.
- The pipe materials included in Table 4.2.1.A2 are allowed for use in meeting the requirements of this manual. Refer to the current edition of *WSDOT/APWA Standard Specifications 7-02, 7-03 and 7-04* for detailed specifications for acceptable pipe materials.

TABLE 4.2.1.A2 ALLOWABLE PIPE MATERIALS AND MINIMUM COVER				
Pipe Type	Minimum Cover (ft)	Public	Private	Allowed in Zone 1 of the APA
Corrugated Steel Pipe	2.0	Yes	Yes	Yes
Spiral Rib Steel Pipe	2.0	Yes	Yes	Yes
Plain Concrete Pipe (PCP)	2.0	No	Yes	No
Reinforced Concrete Pipe (RCP)	1.0	Yes	Yes	No
Ductile Iron	1.0	Yes	Yes	Yes
Line Corrugated Polyethylene Pipe (LCPE)	2.0	Yes	Yes	Yes
Corrugated Polyethylene Pipe (CPE) – Triple Wall	2.0	Yes	Yes	Yes
Polypropylene Pipe (PP) – Dual Wall	2.0	Yes	Yes	Yes
Polyvinyl Chloride Pipe (PVC)	3.0	Yes	Yes	Yes
Solid Wall High Density Polyethylene Pipe (HDPE)	2.0	Yes	Yes	Yes

Allowable Pipe Joints

- Concrete pipe shall be rubber gasketed.
- Corrugated steel pipe shall be rubber gasketed and securely banded.
- Spiral rib steel pipe shall be “hat-banded” with neoprene gaskets.
- Ductile iron pipe joints shall be flanged, bell and spigot, or restrained mechanical joints.
- PP and CPE pipe joints (lined and single wall, fully corrugated) shall conform to the current *WSDOT/APWA Standard Specifications*.

6. PVC pipe, CPE pipe and PP pipe shall be installed following procedures outlined in ASTM D2321. Solid wall HDPE pipe shall be jointed by butt fusion methods or flanged according to the *City of Renton Standard Details*.

Pipe Alignment

1. Pipes must be laid true to line and grade with no curves, bends, or deflections in any direction.
2. **Exception:** Vertical deflections in solid wall HDPE and ductile iron pipe with flanged restrained mechanical joint bends (not greater than 30°) on steep slopes, provided the pipe drains.
3. A **break in grade** or alignment, or changes in pipe material shall occur only at catch basins or manholes.

Allowable Pipe Slopes and Velocities

Table 4.2.1.A3 presents allowable pipe slopes and velocities by pipe material.

TABLE 4.2.1.A3 ALLOWABLE PIPE SLOPES AND VELOCITIES					
Pipe Material	Minimum Slope Allowed ⁽³⁾	Pipe Slope above which Pipe Anchors Required and Minimum Anchor Spacing	Maximum Slope Allowed	Minimum Velocity at Full Flow ⁽³⁾	Maximum Velocity at Full Flow
Steel or PVC ⁽¹⁾	0.5%	20% (1 anchor per 100 LF of pipe)	30% ⁽⁴⁾	3 fps	30 fps
Concrete, CPE, or PP ⁽¹⁾	0.5%	10% (1 anchor per 50 LF of pipe)	20% ⁽⁴⁾	3 fps	30 fps
Ductile Iron ⁽²⁾	0.5%	20% (1 anchor per pipe section)	None	3 fps	None
Solid wall HDPE ⁽²⁾	0.5%	20% (1 anchor per 100 LF of pipe, cross-slope installations only)	None	3 fps	None
<p><i>Notes:</i></p> <p>(1) These materials are not allowed in landslide hazard areas.</p> <p>(2) Butt-fused or flanged pipe joints are required; above ground installation is recommended on slopes greater than 40%.</p> <p>(3) Minimum slope and full flow velocity is required unless it cannot be achieved due to outlet control, site topography, burial depth or other situations or conditions.</p> <p>(4) A maximum slope of 200% is allowed for these pipe materials with no joints (one section), with structures at each end, and with proper grouting.</p>					

Changes in Pipe Size

1. Increase or decreases in pipe size are **allowed only at structures**. Exceptions may be allowed as follows:

Connections to pipe systems may be made without placing a catch basin or manhole on the mainline by meeting all of the following conditions:

- a) The mainline pipe is 48 inches or greater and at least two times the size of the connecting pipe.
- b) Make connections in accordance with the manufacture's recommendations. Standard shop fabricated tees, wyes and saddles shall be used, except for concrete connections constructed in accordance with the City of Renton Standard Details.
- c) There shall be a catch basin or manhole on the connecting pipe within 2 to 10 feet of the external wall of the main line.

- d) Offset angle of connecting pipe to mainline, horizontally and vertically shall be less than 45 degrees.
 - e) Two-point survey control shall be used to set catch basin locations.
2. When **connecting pipes at structures**, match any of the following (in descending order of preference): crowns, 80% diameters,² or inverts of pipes. Side lateral connections³, 12 inches and smaller, are exempt from this requirement.
 3. **Drop manholes** may be used for energy dissipation when pipe velocities exceed 10 feet per second. External drop manholes are preferred where *maintenance* access to the upstream pipe is preserved by use of a tee section. Internal drop structures may be approved only if adequate scour protection is provided for the manhole walls. Drop structures must be individually engineered to account for design variations, such as flow rates, velocities, scour potential and tipping forces.
 4. **Downsizing** pipes larger than 12 inches may be allowed provided pipe capacity is adequate for design flows.

Note: The above criteria do not apply to detention tanks.

Structures

Table 4.2.1.B lists typical drainage *structures* with corresponding maximum allowable pipe sizes.

1. Catch basin (or manhole) diameter shall be determined by pipe orientation at the junction structure. A **plan view of the junction structure**, drawn to scale, will be required when more than four pipes enter the *structure* on the same plane, or if angles of approach and clearance between pipes is of concern. The plan view (and sections if necessary) must ensure a minimum distance (of solid concrete wall) between pipe openings of 8 inches for 48-inch and 54-inch catch basins, and 12 inches for 72-inch and 96-inch catch basins.
2. Evaluation of the structural integrity for **H-20 loading**, or as required by the *City of Renton Standard Details*, may be required for multiple junction catch basins and other *structures*.
3. **All solid wall HDPE pipe systems** (including buried solid wall HDPE pipe) must be secured at the upstream end. The downstream end shall be placed in a 4-foot section of the next larger pipe size. This sliding sleeve connection allows for the high thermal expansion/contraction coefficient of this pipe material.
4. The **maximum slope of the ground surface** for a radius of 5 feet around a catch basin grate or solid lid should be 5:1 (H:V) to facilitate *maintenance* access. Where not physically feasible, a maximum slope of 3:1 (H:V) shall be provided around at least 50% of the catch basin circumference.
5. Catch basins (see *City of Renton Standard Details*) rather than inlets shall be used to collect storm water from road surfaces, unless approved by the City Engineer.
6. Type 2 (see *City of Renton Standard Details*) catch basins shall be used where the depth to the invert of the pipe exceeds 5 feet.
7. Manholes (see *City of Renton Standard Details*) may be used in lieu of catch basins if they do not collect surface water. Manholes must be used if inverts are greater than 18 feet.
8. Roof and yard drains, or other concentrated flow from adjacent property shall not discharge over the surface of roadways, sidewalks, walkways, or shoulders.

² Match point is at 80% of the pipe diameter, measured from the invert of the respective pipes.

³ Side laterals include any 8-inch or smaller pipe connected to the main conveyance system at a catch basin, or manhole, as allowed under this manual and/or the *City of Renton Standard Details*. In addition, 12-inch and smaller pipes that serve a single inlet point (e.g., roadway simple inlets, footing drains, and lot stubouts including manifold systems serving multiple residential lots) are also included. Excluded from this definition are inlet pipes that contribute 30% or more of the total flow into a catch basin, or that collect or convey flows from a continuous source.

9. Catch basins or manholes are required when joining differing types of pipes.
10. The location of at least two points of all catch basins shall be surveyed to ensure that the catch basin, frame and grate will properly align with finished curb, horizontally and vertically.
11. Metal castings for drainage *structures* shall not be dipped, painted, welded, plugged or repaired.
12. Porosity in metal castings for drainage *structures* shall be considered a workmanship defect subject to rejection by the inspector.
13. Grates and covers shall be seated properly to prevent rocking, including the replacement of existing covers with solid metal covers.
14. Unless otherwise specified, vaned grates (see *City of Renton Standard Details*), shall be used with standard frame in the traveled way, gutter, or shoulder. Vaned grates shall not be located within crosswalks.
15. At sag vertical curves, on the end of downgrade cul-de-sacs, or before intersections with a grade four percent or greater, an analysis shall be done to assure that typical catch basin grates will collect the surface runoff. To collect excessive volumes of runoff or protect against plugged grates and overflow situations, the City Road Engineer will require the use of through inlet frames on vertical curbs, (see *City of Renton Standard Details*). Where the through-curb inlets cannot be used, place a catch basin at the low point and two extra inlets located not greater than 0.1 foot above the low point grate within a spacing of 25 feet.
16. New catch basins and manholes that do not collect runoff shall use solid locking covers (per *City of Renton Standard Details*). Existing catch basins, which no longer collect runoff, shall have their frame and grates replaced with solid covers.
17. All storm drain covers and grates need to be locking regardless of their location.
18. Slot drains may be used when approved by the City Engineer. At a minimum, slot drains shall have catch basins at either end unless used as a driveway culvert. The maximum distance between catch basins along a slot drain shall be 50 feet.

TABLE 4.2.1.B ALLOWABLE STRUCTURES AND PIPE SIZES		
Catch Basin Type⁽¹⁾	Maximum Pipe Diameter	
	Steel, Solid Wall HDPE, PVC, and Ductile Iron⁽²⁾	Concrete, CPE, PP
Inlet ⁽⁴⁾	12"	12"
Type 1 ⁽³⁾	18"	12"
Type 1L ⁽³⁾	24"	18"
Type 2 – 48-inch dia.	30"	24"
Type 2 – 54-inch dia.	36"	30"
Type 2 – 72-inch dia.	54"	42"
Type 2 – 96-inch dia.	72"	60"
Notes: (1) Catch basins (including manhole steps, ladder, and handholds) shall conform to the <i>City of Renton Standard Details</i> . (2) Generally these pipe materials will be one size larger than concrete, CPE or PP due to smaller wall thickness. However, for angled connections or those with several pipes on the same plane, this will not apply. (3) A maximum of 5 vertical feet is allowed between finished grade and invert elevation. (4) Inlets are normally allowed only for use in privately maintained drainage systems and must discharge to a catch basin immediately downstream.		

Pipe Design between Structures

1. **Minimum velocity** at full flow should be 3.0 feet per second (fps). If *site* constraints result in velocities less than 3 fps at full flow, impacts from sedimentation in the pipe system shall be addressed with larger pipes, closer spacing of *structures*, sediment basins, or other similar measures.
2. **Minimum slope** for pipes shall be 0.5%, unless otherwise approved by *CED* in locations with *site* constraints provided that the minimum velocity requirement of 3 fps is met.
3. **Maximum lengths** between *structures* shall meet the requirements in Table 4.2.1.A1 above. Solid wall HDPE tightlines down steep slopes are self-cleaning and do not require *structures* for *maintenance*.

Pipe Cover

1. Pipe cover, measured from the finished grade elevation to the top of the outside surface of the pipe, shall be **2 feet minimum** unless otherwise specified or allowed below or as allowed above in Table 4.2.1.A2. Under drainage easements, driveways, parking stalls, or other areas subject to light vehicular loading, pipe cover may be reduced to 1 foot minimum if the design considers expected vehicular loading and the cover is consistent with pipe manufacturer's recommendations. Pipe cover in areas not *subject to vehicular loads*, such as landscape planters and yards, may be reduced to 1 foot minimum.
2. All flexible storm sewer pipe and culvert material shall be covered by a minimum of 2 feet of cover unless the applicant submits detailed plans accompanied by manufacturer's recommendations specifying allowable cover less than 2 feet in depth. All non-flexible storm sewer pipe and culvert material shall be covered by a minimum of 1 foot of cover. Pipe **cover over concrete pipe** shall comply with Table 4.2.1.C. For other pipe types, the manufacturer's specifications or other documentation shall be provided for proposed cover in excess of 30 feet. *Caution: Additional precautions to protect against crushing during construction may be needed under roadways if the road bed is included to meet minimum cover requirements. Damaged pipe shall be replaced.*
3. For proposed **pipe arches**, the manufacturer's specifications or other documentation shall be provided for proposed cover in excess of 8 feet.
4. Pipe cover over **PVC SDR 35** shall be 3 feet minimum and 30 feet maximum.

TABLE 4.2.1.C MAXIMUM COVER (FEET) FOR CONCRETE PIPE

Pipe Diameter (inches)	Plain	Class II	Class III	Class IV	Class V
12	18	10	14	21	26
18	18	11	14	22	28
24	16	11	15	22	28
30		11	15	23	29
36		11	15	23	29
48		12	15	23	29
60		12	16	24	30
72		12	16	24	30
84		12	16	24	30
96		12	16	24	30
108		12	16	24	30

Note: See Figure 4.2.1.A for a schematic representation. Only Class IV and V are allowed in public right-of-way.

Pipe Clearances

A minimum 7-foot horizontal separation and 1-foot vertical separation (measured wall to wall) is required between storm pipe and other utilities with the exception of water lines where a minimum 10-foot

horizontal separation and 1.5-foot vertical separation (measured wall to wall) is required, unless otherwise approved by *CED* in locations with *site* constraints.

Pipe Bedding, Backfill and Compaction

Pipe bedding and backfill shall be in accordance with the *City of Renton Standard Details*. Pipe compaction shall follow the current *WSDOT Standard Specifications*. Where pipes pass through flood containment *structures*, these standards shall be supplemented and modified as necessary in accordance with standards set forth in *Corps of Engineers Manual for Design and Construction of Levees* (EM 1110-2-1913).

Pipe System Connections

Connections to a pipe system shall be made only at catch basins or manholes. No wyes or tees are allowed except on roof/footing/yard drain systems on pipes 8 inches in diameter or less, with clean-outs upstream of each wye or tee.

Additional exceptions may be made provided the following conditions are met:

1. The mainline pipe is 48 inches or greater and at least two times the size of the connecting pipe.
2. Make connections in accordance with the manufacturer's recommendations. Standard shop fabricated tees, wyes and saddles shall be used, except for concrete connections constructed in accordance with the *City of Renton Standard Details*.
3. There shall be a catch basin or manhole on the connecting pipe within 2 to 10 feet of the external wall of the main line.
4. Offset angle of connecting pipe to mainline, horizontally and vertically shall be less than 45 degrees.

Storm drainage pipe systems shall not penetrate building foundations, except for sump pump discharge lines used to drain crawl spaces, provided the sump pump system includes a backflow prevention or a check valve.

An area drain within a crawl space is allowed to connect into the storm drainage system provided the following conditions are met:

1. The connection is to be tight lined a minimum of ten feet outside of the foundation, and in no case connected upstream of the footing drain system for the house.
2. The area drain must be routed through a sump pump system prior to connection to the public storm drainage system, to help prevent backup during surcharge conditions and of potential sewer gas into the crawl space area.

Pipe Anchors

Table 4.2.1.A3 presents the requirements, by pipe material, for anchoring pipe systems. Figure 4.2.1.B and Figure 4.2.1.C show schematic representations of pipe anchors.

Spill Control

Where spill control is required as specified in Section 1.2.4.3.G, allowable options are as follows:

- a) A **tee section** (see Figure 5.1.4.A) in or subsequent to the last catch basin or manhole that collects runoff from non-roof-top ***pollution-generating impervious surface*** prior to discharge from the *site* or into an ***onsite natural drainage feature***.⁴ The tee section typically provided in a wetvault or detention facility may be used to meet the intent of this requirement. Unless otherwise specified, the riser top of the tee section shall be at or above the headwater elevation for the 10-year design

⁴ *Natural onsite drainage feature* means a natural swale, channel, stream, closed depression, wetland, or lake.

flow and a minimum of 6 inches below the ceiling of the catch basin or manhole. The bottom end of the tee section shall be as illustrated in Figure 5.1.4.A.

- b) A **wall section** or other device as approved by the City that provides spill control equivalent to that of the tee section specified in a) above.
- c) A **baffle or coalescing plate oil/water separator** at or subsequent to the last catch basin or manhole that collects runoff from non-roof-top ***pollution-generating impervious surface*** prior to discharge from the ***site*** or into an ***onsite*** natural drainage feature.
- d) An **active spill control plan**. To use this option, the spill control plan and summary of an existing or proposed training schedule must be submitted as part of the drainage review submittal. At a minimum, such plans must include the following:
 - Instructions for isolating the ***site*** to prevent spills from moving downstream (shutoff valves, blocking catch basins, etc.)
 - ***Onsite*** location of spill clean-up materials
 - Phone numbers to call for emergency response
 - Phone numbers of company officials to notify
 - Special safety precautions, if applicable.

Debris Barriers

Debris barriers (trash racks) are required on all pipes 18 to 36 inches in diameter entering a closed pipe system. Debris barriers for pipes smaller than 18 inches and larger than 36 inches in diameter may be required depending on conditions and safety concerns. Debris barriers shall have a bar spacing of 6 inches. See Figure 4.2.1.D for a schematic representation of debris barriers on pipe ends outside of roadways. See Figure 4.2.1.E and Section 4.3 for a schematic representation of debris barriers on pipe ends (culverts) projecting from driveway or roadway side slopes.

Outfalls

Outfalls shall be designed as detailed in Section 4.2.2.

Other Details

In addition to the schematic representations provided in Figure 4.2.1.A through Figure 4.2.1.E, standard construction details are available in the *City of Renton Standard Details* and *APWA/WSDOT Standard Plans for Road, Bridge and Municipal Construction*. Commonly used details include field tapping of concrete pipe, catch basins and catch basin details, manholes and manhole details, curb inlets, frames, grates, and covers.

FIGURE 4.2.1.A SCHEMATIC REPRESENTATION OF PIPE BEDDING AND BACKFILL DESIGNS

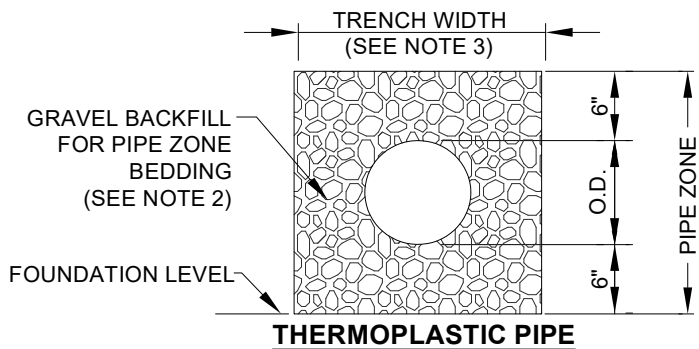
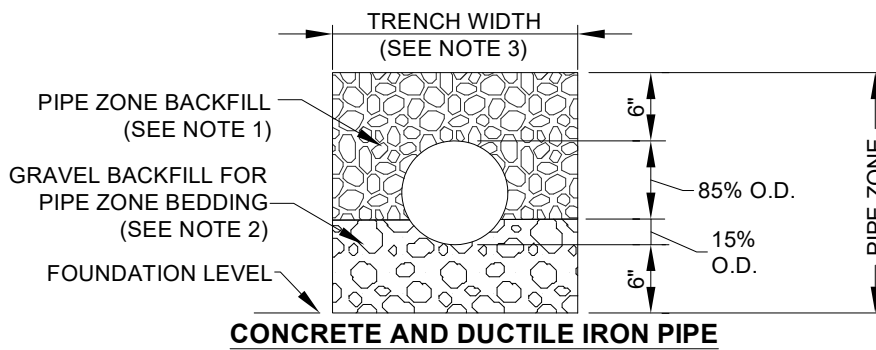
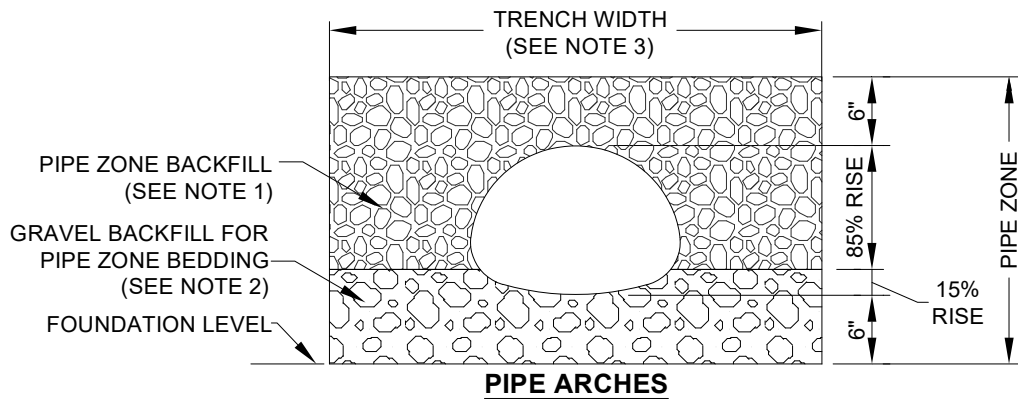

NOTE:
ALL DETAILS
NOT TO SCALE

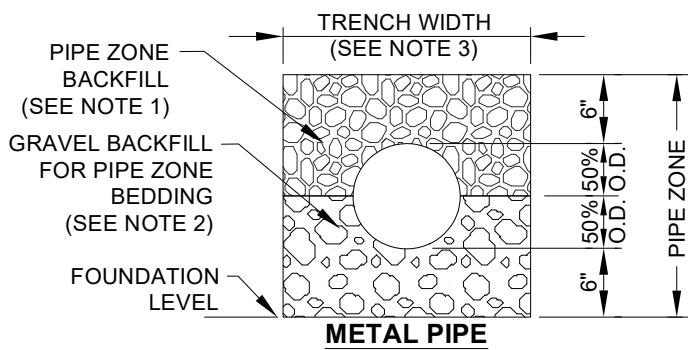

- NOTES:**
1. SEE CURRENT WSDOT STANDARD SPECIFICATIONS SECTION 7-08.3(3) FOR PIPE ZONE BACKFILL.
 2. SEE CURRENT WSDOT STANDARD SPECIFICATIONS SECTION 9-03.12(3) FOR GRAVEL BACKFILL FOR PIPE ZONE BEDDING.
 3. SEE CURRENT WSDOT STANDARD SPECIFICATIONS SECTION 2-09.4 FOR MEASUREMENT OF TRENCH WIDTH.
 4. SEE KCSWDM 4.2.1.1 FOR CLEARANCE BETWEEN PIPES AND OTHER UTILITIES.

FIGURE 4.2.1.B SCHEMATIC REPRESENTATION OF A PIPE ANCHOR DETAIL

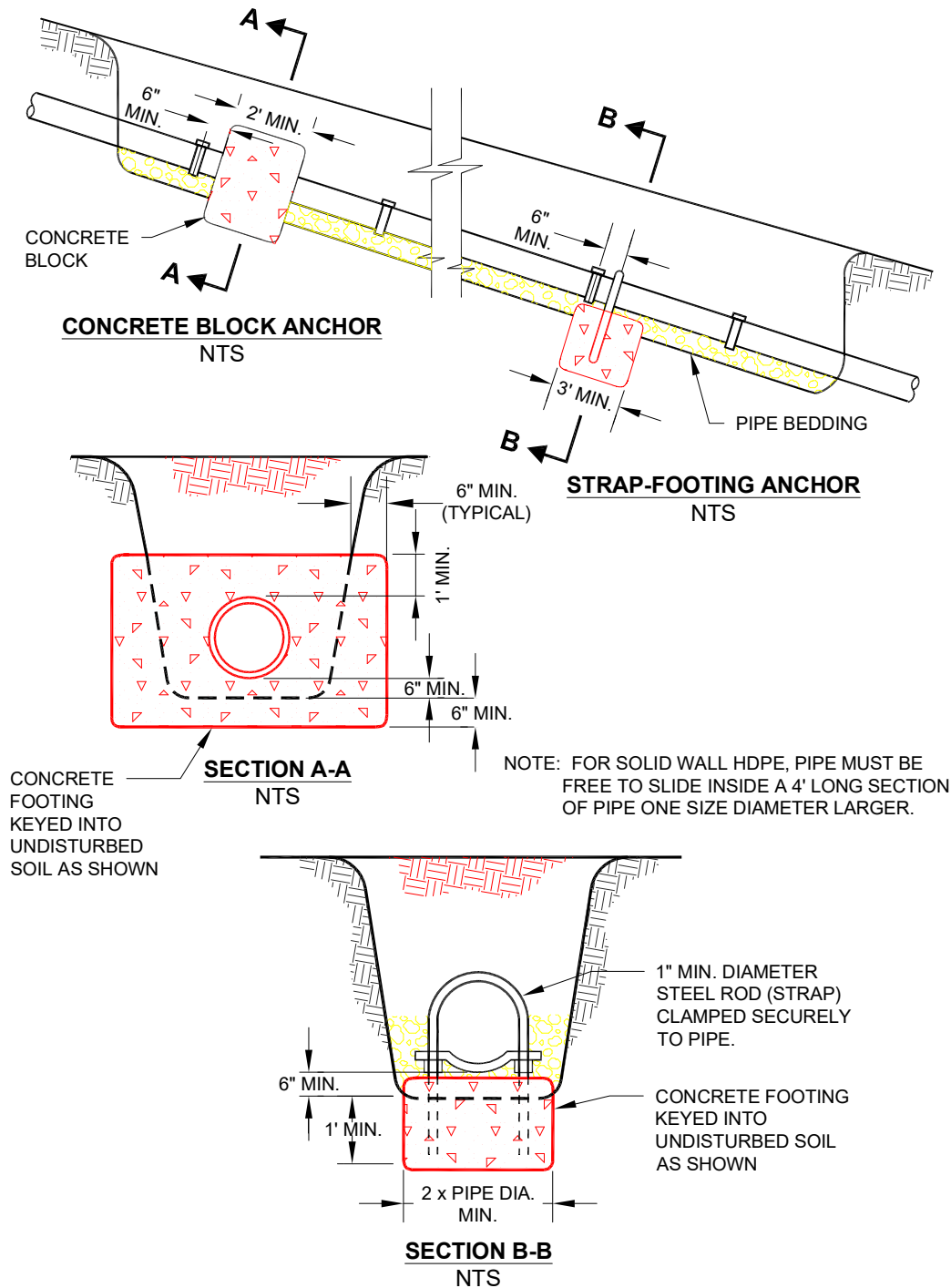
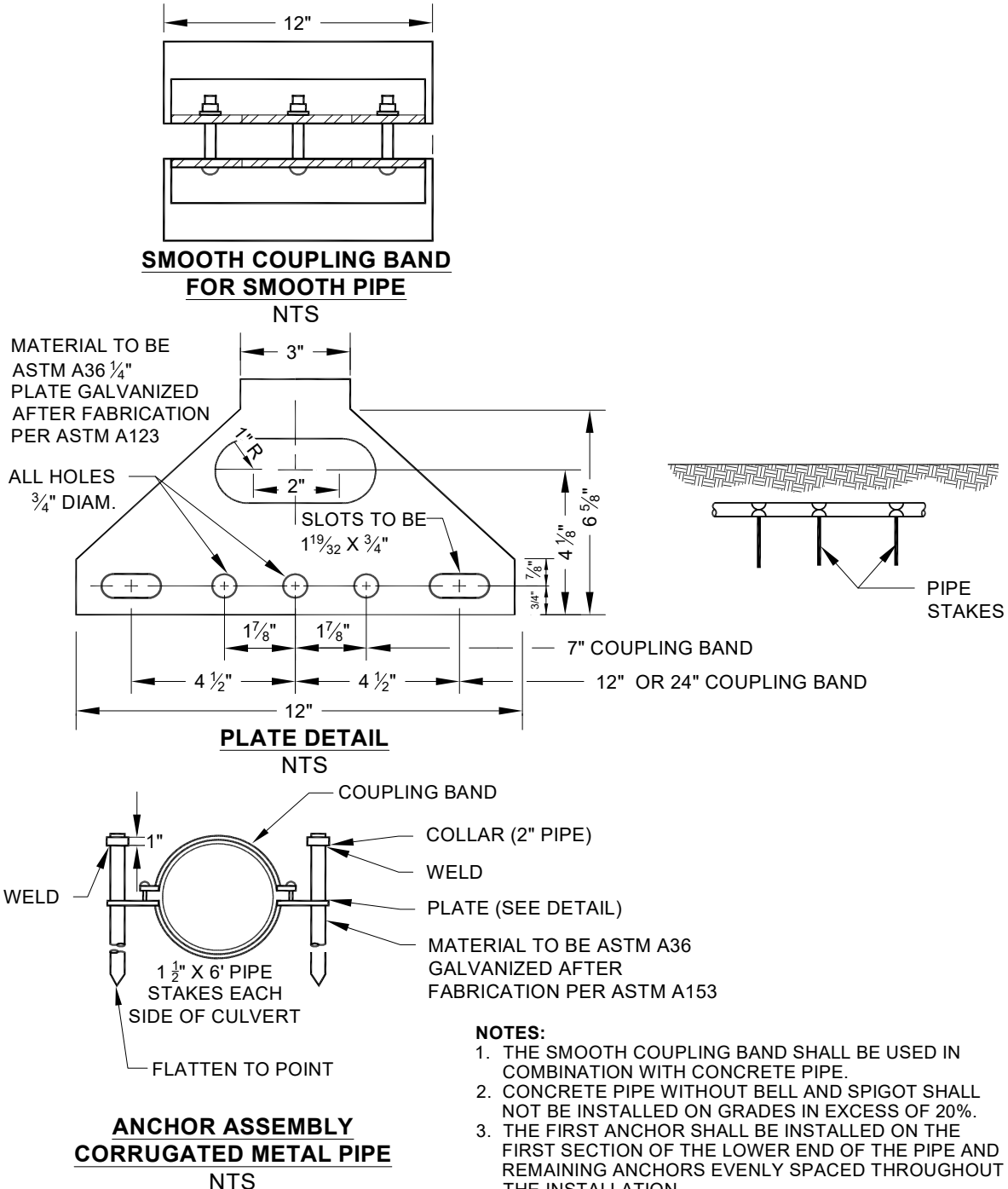

FIGURE 4.2.1.C SCHEMATIC REPRESENTATION OF CORRUGATED METAL PIPE COUPLING AND/OR GENERAL PIPE ANCHOR ASSEMBLY



- NOTES:**
1. THE SMOOTH COUPLING BAND SHALL BE USED IN COMBINATION WITH CONCRETE PIPE.
 2. CONCRETE PIPE WITHOUT BELL AND SPIGOT SHALL NOT BE INSTALLED ON GRADES IN EXCESS OF 20%.
 3. THE FIRST ANCHOR SHALL BE INSTALLED ON THE FIRST SECTION OF THE LOWER END OF THE PIPE AND REMAINING ANCHORS EVENLY SPACED THROUGHOUT THE INSTALLATION.
 4. IF THE PIPE BEING INSTALLED HAS A MANHOLE OR CATCH BASIN ON THE LOWER END OF THE PIPE, THE FIRST PIPE ANCHOR MAY BE ELIMINATED.
 5. WHEN CMP IS USED, THE ANCHORS MAY BE ATTACHED TO THE COUPLING BANDS USED TO JOIN THE PIPE AS LONG AS THE SPECIFIED SPACING IS NOT EXCEEDED.
 6. ALL PIPE ANCHORS SHALL BE SECURELY INSTALLED BEFORE BACKFILLING AROUND THE PIPE.

FIGURE 4.2.1.D SCHEMATIC REPRESENTATION OF A DEBRIS BARRIER (OFF-ROAD RIGHT-OF-WAY)

NOTES:

1. THIS DEBRIS BARRIER IS FOR USE OUTSIDE ROADWAYS ON PIPES 18" DIA. TO 36" DIA.. SEE FIGURE 4.2.1.E FOR DEBRIS BARRIERS ON PIPES PROJECTING FROM DRIVEWAY OR ROADWAY SIDE SLOPES.
2. ALL STEEL PARTS MUST BE GALVANIZED AND ASPHALT COATED (TREATMENT 1 OR BETTER).
3. LINED CPE PIPE REQUIRES BOLTS TO SECURE DEBRIS BARRIER TO PIPE.

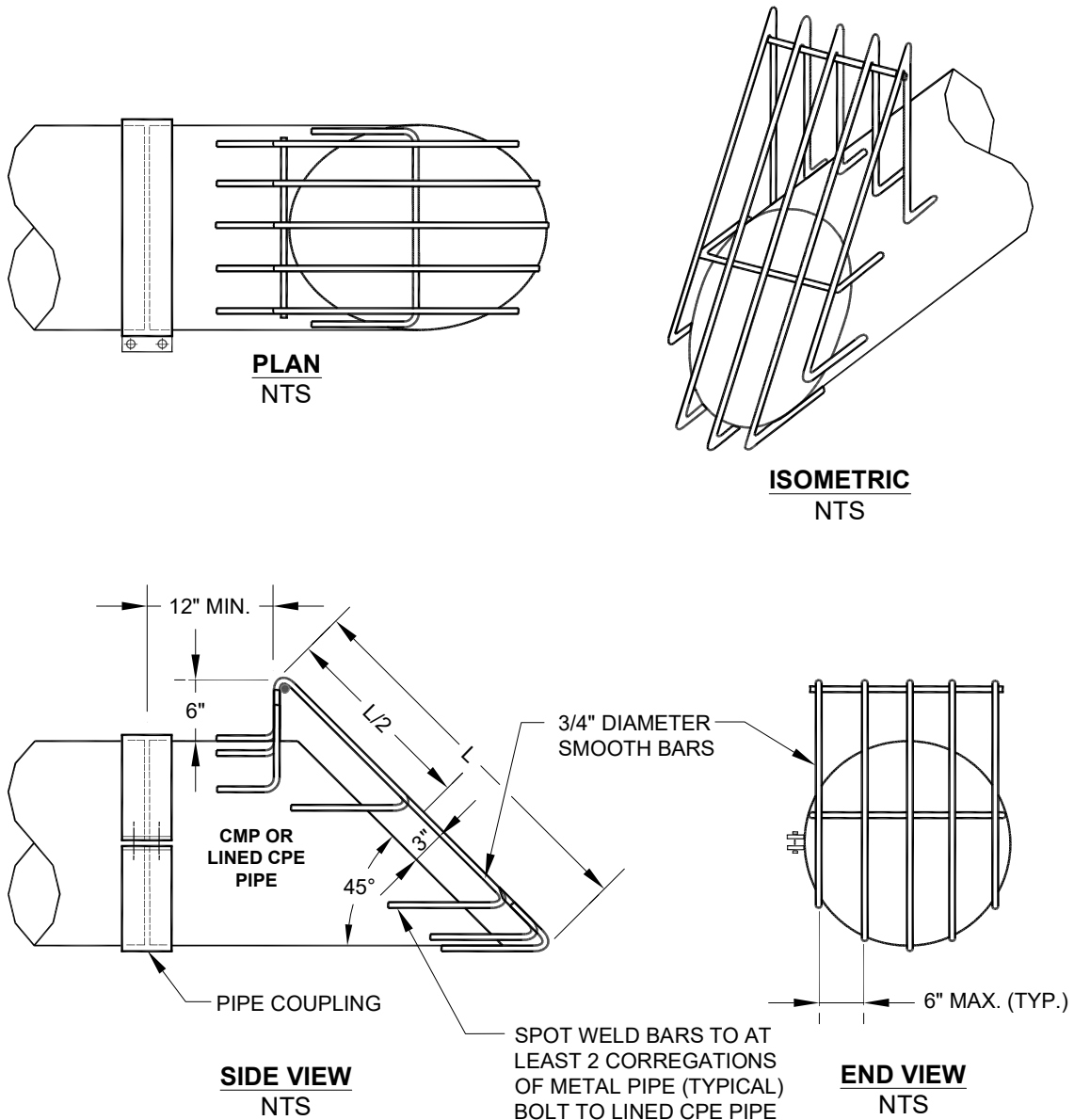

**FIGURE 4.2.1.E SCHEMATIC REPRESENTATION OF A DEBRIS BARRIER
(IN ROAD RIGHT-OF-WAY)**

NOTES:

1. CMP OR LINED CPE PIPE END-SECTION SHOWN; FOR CONCRETE PIPE BEVELED END SECTION, SEE KCRDCS DRAWING NO. 7-001.
2. ALL STEEL PARTS MUST BE GALVANIZED AND ASPHALT COATED (TREATMENT 1 OR BETTER).

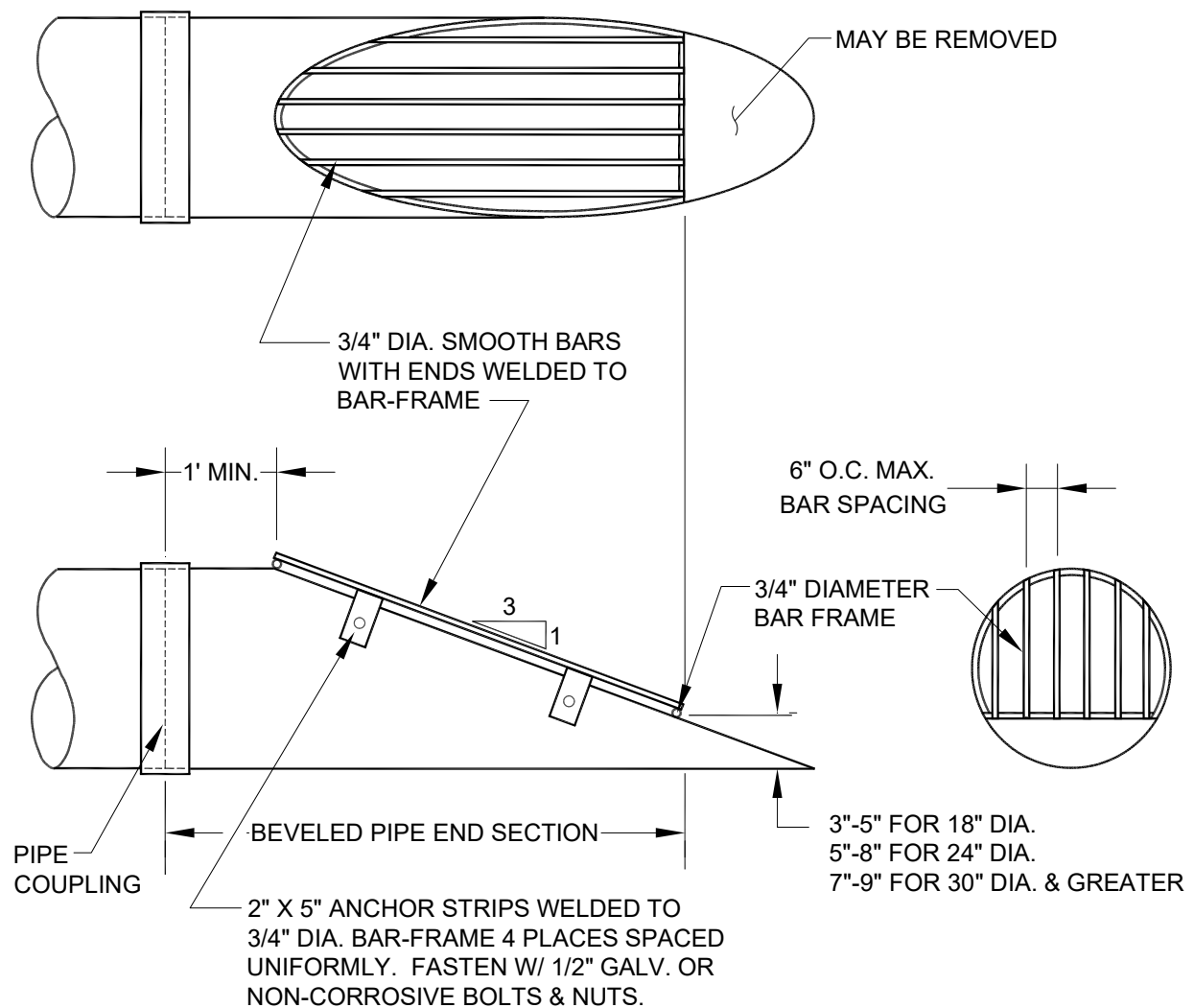

4.2.1.2 METHODS OF ANALYSIS

This section presents the methods of analysis for designing new or evaluating existing **pipe systems** for compliance with the conveyance capacity requirements set forth in Section 1.2.4, “Core Requirement #4: Conveyance System.”

❑ DESIGN FLOWS

Design flows for sizing or assessing the capacity of pipe systems shall be determined using the hydrologic analysis methods described in Chapter 3.

❑ INLET GRATE CAPACITY

The methods described in Chapter 5, Sections 4 and 5, of the *Washington State Department of Transportation (WSDOT) Hydraulics Manual* may be used in determining the capacity of inlet grates when capacity is of concern, with the following exceptions:

1. Use design flows as required in Section 1.2.4 of this manual.
2. Assume grate areas on slopes are 80% free of debris; “vaned” grates, 95% free.
3. Assume grate areas in sags or low spots are 50% free of debris; “vaned” grates, 75% free.

❑ CONVEYANCE CAPACITY

Two methods of hydraulic analysis using Manning's equation are used sequentially for the design and analysis of pipe systems. First, the **Uniform Flow Analysis method** is used for the preliminary design of new pipe systems. Second, the **Backwater Analysis method** is used to analyze both proposed and existing pipe systems to verify adequate capacity. See Core Requirement #4, Section 1.2.4, for sizing requirements of pipe systems.

Note: Use of the Uniform Flow Analysis method to determine preliminary pipe sizes is only suggested as a first step in the design process and is not required. Results of the Backwater Analysis method determine final pipe sizes in all cases.

Uniform Flow Analysis Method

In addition to the design criteria described below, new pipe systems shall be design to meet the hydraulic criteria as described in Section 1.2.4.1.

This method is used for **preliminary sizing** of new pipe systems to convey the *design flow* (i.e., the 10-year or 25-year peak flow rate as specified in Core Requirement #4, Section 1.2.4).

Assumptions:

- Flow is uniform in each pipe (i.e., depth and velocity remain constant throughout the pipe for a given flow).
- Friction head loss in the pipe barrel alone controls capacity. Other head losses (e.g., entrance, exit, junction, etc.) and any backwater effects or inlet control conditions are not specifically addressed.

Each pipe within the system is sized and sloped such that its **barrel capacity at normal full flow** (computed by Manning's equation) is equal to or greater than the design flow. The nomograph in Figure 4.2.1.F may be used for an approximate solution of Manning's equation. For more precise results, or for partial pipe full conditions, solve Manning's equation directly:

$$V = \frac{1.49}{n} R^{2/3} S^{1/2} \quad (4-1)$$

or use the continuity equation, $Q = AV$, such that:

$$Q = \frac{1.49}{n} A R^{2/3} S^{1/2} \quad (4-2)$$

where

- Q = discharge (cfs)
- V = velocity (fps)
- A = area (sf)
- n = Manning's roughness coefficient; see Table 4.2.1.D below
- R = hydraulic radius = area/wetted perimeter (ft)
- S = slope of the energy grade line (ft/ft)

For **pipes flowing partially full**, the actual velocity may be estimated from the hydraulic properties shown in Figure 4.2.1.G by calculating Q_{full} and V_{full} and using the ratio Q_{design}/Q_{full} to find V and d (depth of flow).

Table 4.2.1.D provides the recommended **Manning's "n" values for preliminary design** using the Uniform Flow Analysis method for pipe systems. *Note: The "n" values for this method are 15% higher in order to account for entrance, exit, junction, and bend head losses.*

TABLE 4.2.1.D MANNING'S "n" VALUES FOR PIPES		
Type of Pipe Material	Analysis Method	
	Uniform Flow (preliminary design)	Backwater Flow (capacity verification)
A. Concrete pipe, lined CPE pipe and lined PP pipe	0.014	0.012
B. Annular Corrugated Steel Pipe or Pipe Arch:		
1. 2- ² / ₃ " x 1/2" corrugation (riveted):		
a. plain or fully coated	0.028	0.024
b. paved invert (40% of circumference paved):		
1) flow at full depth	0.021	0.018
2) flow at 80% full depth	0.018	0.016
3) flow at 60% full depth	0.015	0.013
c. treatment 5	0.015	0.013
2. 3" x 1" corrugation	0.031	0.027
3. 6" x 2" corrugation (field bolted)	0.035	0.030
C. Helical 2- ² / ₃ " x 1/2" corrugation and unlined CPE pipe	0.028	0.024
D. Spiral rib metal pipe and PVC pipe	0.013	0.011
E. Ductile iron pipe cement lined	0.014	0.012
F. Solid wall HDPE pipe (butt fused only)	0.009	0.009

Backwater Analysis Method

This method is used to analyze the capacity of both new and existing pipe systems to convey the required design flow (i.e., either the 10-year or 25-year peak flow, whichever is specified in Core Requirement #4, Section 1.2.4). In either case, pipe system **structures** must be demonstrated to contain the **headwater surface** (hydraulic grade line) for the specified peak flow rate. **Structures** may overtop for the 100-year peak flow as allowed by Core Requirement #4. When this occurs, the additional flow over the ground surface is analyzed using the methods for open channels described in Section 4.4.1.2 and added to the flow capacity of the pipe system.

This method is used to compute a **simple backwater profile** (hydraulic grade line) through a proposed or existing pipe system for the purposes of verifying adequate capacity. It incorporates a re-arranged form of Manning's equation expressed in terms of *friction slope* (slope of the energy grade line in ft/ft). The friction slope is used to determine the head loss in each pipe segment due to barrel friction, which can then be combined with other head losses to obtain water surface elevations at all **structures** along the pipe system.

The backwater analysis begins at the downstream end of the pipe system and is computed back through each pipe segment and **structure** upstream. The friction, entrance, and exit head losses computed for each pipe segment are added to that segment's tailwater elevation (the water surface elevation at the pipe's outlet) to obtain its **outlet control** headwater elevation. This elevation is then compared with the **inlet control** headwater elevation, computed assuming the pipe's inlet alone is controlling capacity using the methods for inlet control presented in Section 4.3.1.2. The condition that creates the highest headwater elevation determines the pipe's capacity. The approach velocity head is then subtracted from the controlling headwater elevation, and the junction and bend head losses are added to compute the total headwater elevation, which is then used as the tailwater elevation for the upstream pipe segment.

The **Backwater Calculation Sheet** in Figure 4.2.1.H may be used to compile the head losses and headwater elevations for each pipe segment. The numbered columns on this sheet are described in Figure 4.2.1.I. An example calculation is performed in Figure 4.2.1.J.

Note: This method should not be used to compute stage/discharge curves for level pool routing purposes. Instead, a more sophisticated backwater analysis using the computer software provided with this manual is recommended as described below.

Computer Applications

The **King County Backwater (KCBW) computer program** includes a subroutine **BWPIPE**, which may be used to quickly compute a family of backwater profiles for a given range of flows through a proposed or existing pipe system. A schematic description of the nomenclature used in this program is provided in Figure 4.3.1.G. Program documentation providing instructions on the use of this and the other KCBW subroutines is available from King County Department of Natural Resources and Parks (DNRP).

FIGURE 4.2.1.F NOMOGRAPH FOR SIZING CIRCULAR DRAINS FLOWING FULL

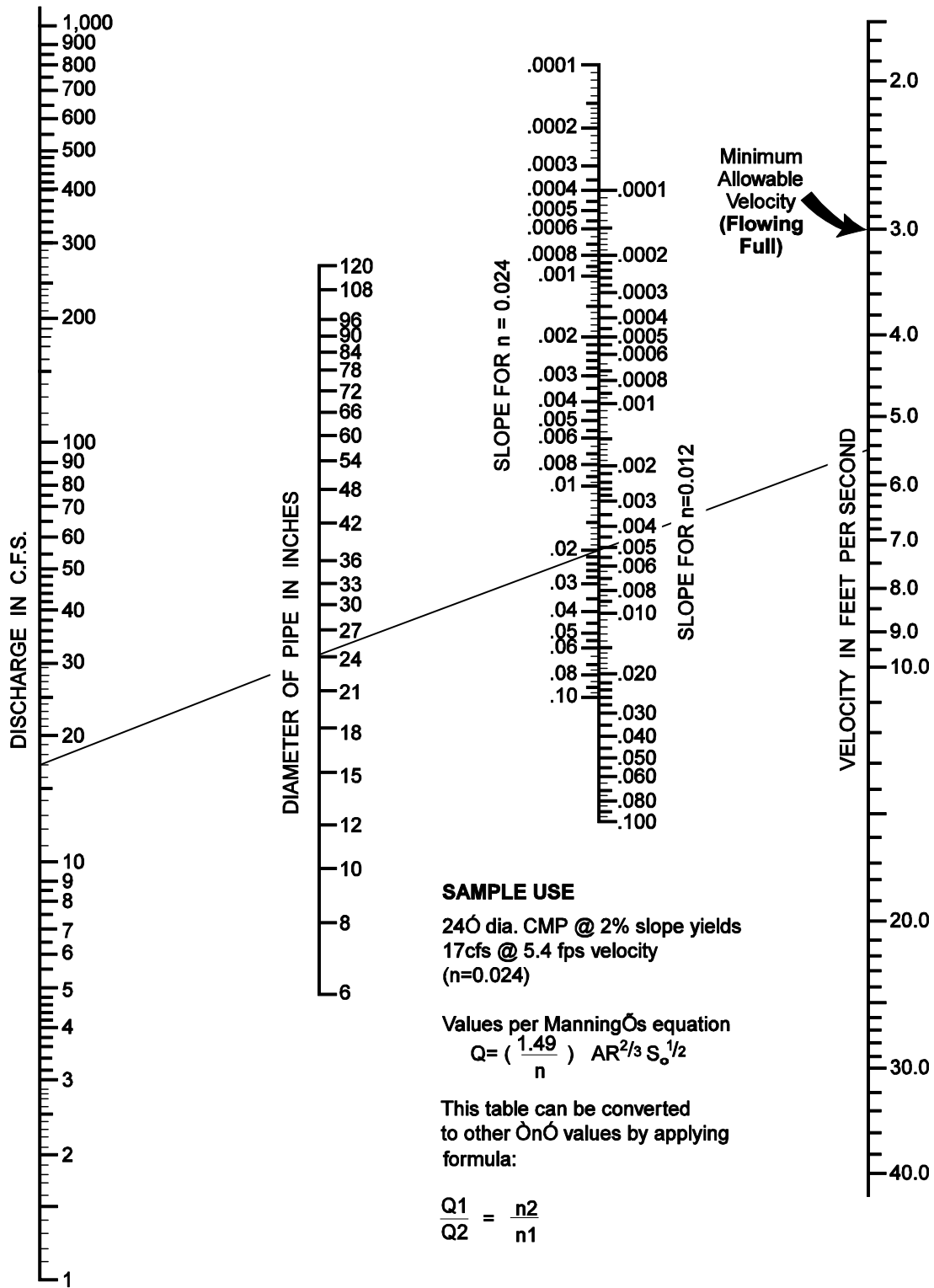

FIGURE 4.2.1.G CIRCULAR CHANNEL RATIOS

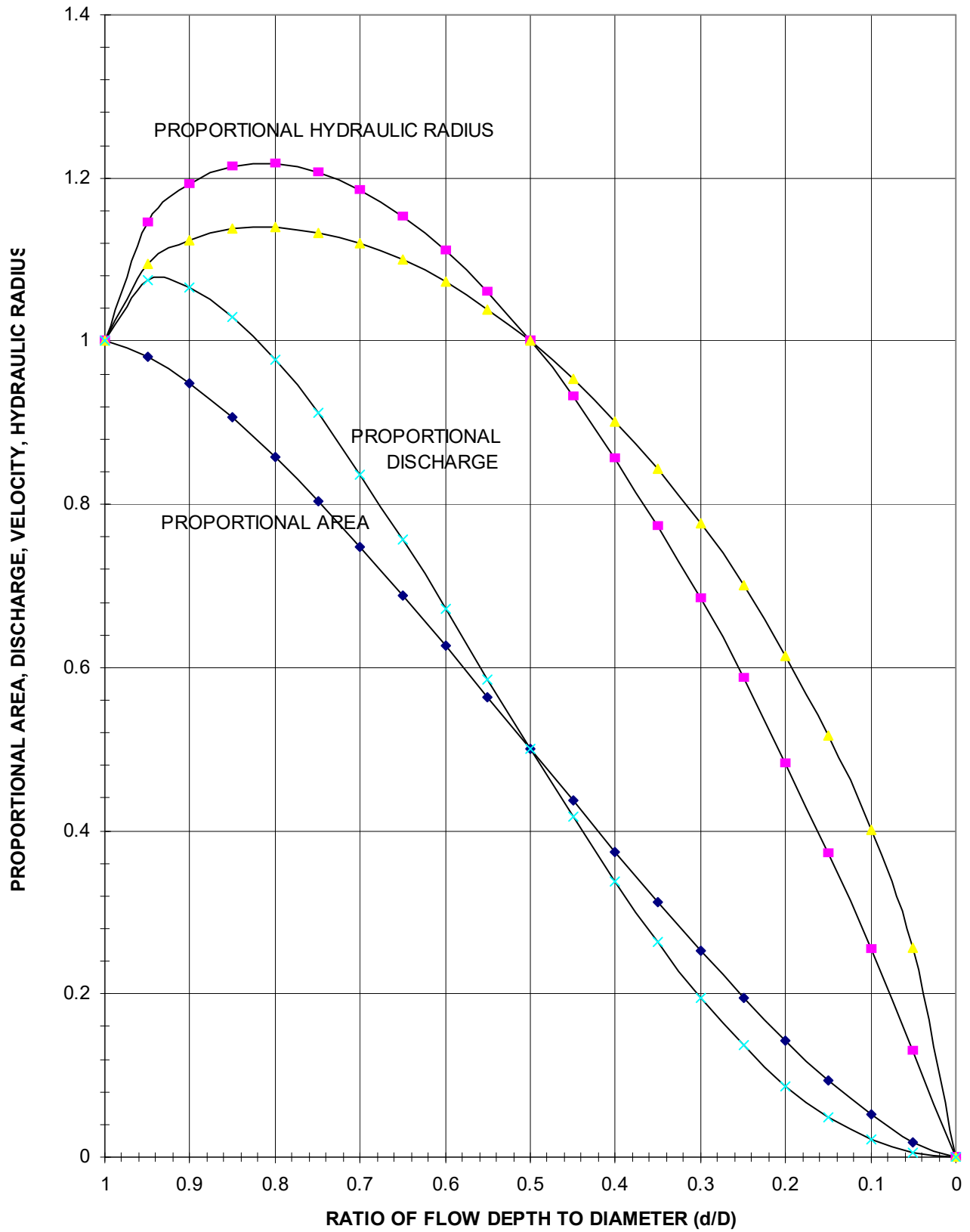

FIGURE 4.2.1.H BACKWATER CALCULATION SHEET

Pipe Segment CB to CB	(1) Q (cfs)	(2) Length (ft)	(3) Pipe Size	(4) C Value	(5) Outlet Elev (ft)	(6) Inlet Elev (ft)	(7) Barrel Barrel Area (sq. ft)	(8) Barrel Barrel Vel (fps)	(9) Barrel Vel Head (ft)	(10) TW Elev (ft)	(11) Fric- tion Loss (ft)	(12) Entr HGL Elev (ft)	(13) Entr Head Loss (ft)	(14) Exit Head Loss (ft)	(15) Outlet Cntrl Elev (ft)	(16) Inlet Cntrl Elev (ft)	(17) Appr Vel Head (ft)	(18) Bend Head Loss (ft)	(19) Junc Head Loss (ft)	(20) HW Elev (ft)	

FIGURE 4.2.1.I BACKWATER CALCULATION SHEET NOTES

- Column (1) - Design flow to be conveyed by pipe segment.
- Column (2) - Length of pipe segment.
- Column (3) - Pipe Size; indicate pipe diameter or span x rise.
- Column (4) - Manning's "n" value.
- Column (5) - Outlet Elevation of pipe segment.
- Column (6) - Inlet Elevation of pipe segment.
- Column (7) - Barrel Area; this is the full cross-sectional area of the pipe.
- Column (8) - Barrel Velocity; this is the full velocity in the pipe as determined by:

$$V = Q/A \text{ or } \text{Col.}(8) = \text{Col.}(1) / \text{Col.}(7)$$
- Column (9) - Barrel Velocity Head = $V^2/2g$ or $(\text{Col.}(8))^2/2g$
 where $g = 32.2 \text{ ft/sec}^2$ (acceleration due to gravity)
- Column (10) - Tailwater (TW) Elevation; this is the water surface elevation at the outlet of the pipe segment. If the pipe's outlet is not submerged by the TW and the TW depth is less than $(D+d_c)/2$, set TW equal to $(D+d_c)/2$ to keep the analysis simple and still obtain reasonable results (D = pipe barrel height and d_c = critical depth, both in feet. See Figure 4.3.1.F for determination of d_c).
- Column (11) - Friction Loss = $S_f \times L$ [or $S_f \times \text{Col.}(2)$]
 where S_f is the friction slope or head loss per linear foot of pipe as determined by Manning's equation expressed in the form:

$$S_f = (nV)^2/2.22 R^{133}$$
- Column (12) - Hydraulic Grade Line (HGL) Elevation just inside the entrance of the pipe barrel; this is determined by adding the friction loss to the TW elevation:

$$\text{Col.}(12) = \text{Col.}(11) + \text{Col.}(10)$$

 If this elevation falls below the pipe's inlet crown, it no longer represents the true HGL when computed in this manner. The true HGL will fall somewhere between the pipe's crown and either normal flow depth or critical flow depth, whichever is greater. To keep the analysis simple and still obtain reasonable results (i.e., erring on the conservative side), set the HGL elevation equal to the crown elevation.
- Column (13) - Entrance Head Loss = $K_e \times V^2/2g$ [or $K_e \times \text{Col.}(9)$]
 where K_e = Entrance Loss Coefficient (from Table 4.3.1.B). This is the head lost due to flow contractions at the pipe entrance.
- Column (14) - Exit Head Loss = $1.0 \times V^2/2g$ or $1.0 \times \text{Col.}(9)$
 This is the velocity head lost or transferred downstream.
- Column (15) - Outlet Control Elevation = $\text{Col.}(12) + \text{Col.}(13) + \text{Col.}(14)$
 This is the maximum headwater elevation assuming the pipe's barrel and inlet/outlet characteristics are controlling capacity. It does not include structure losses or approach velocity considerations.
- Column (16) - Inlet Control Elevation (see Section 4.3.1.2, for computation of inlet control on culverts); this is the maximum headwater elevation assuming the pipe's inlet is controlling capacity. It does not include structure losses or approach velocity considerations.
- Column (17) - Approach Velocity Head; this is the amount of head/energy being supplied by the discharge from an upstream pipe or channel section, which serves to reduce the headwater elevation. If the discharge is from a pipe, the approach velocity head is equal to the barrel velocity head computed for the upstream pipe. If the upstream pipe outlet is significantly higher in elevation (as in a drop manhole) or lower in elevation such that its discharge energy would be dissipated, an approach velocity head of zero should be assumed.
- Column (18) - Bend Head Loss = $K_b \times V^2/2g$ [or $K_b \times \text{Col.}(17)$]
 where K_b = Bend Loss Coefficient (from Figure 4.2.1.K). This is the loss of head/energy required to change direction of flow in an access structure.
- Column (19) - Junction Head Loss. This is the loss in head/energy that results from the turbulence created when two or more streams are merged into one within the access structure. Figure 4.2.1.L may be used to determine this loss, or it may be computed using the following equations derived from Figure 4.2.1.L:

$$\text{Junction Head Loss} = K_j \times V^2/2g \text{ [or } K_j \times \text{Col.}(17)\text{]}$$

 where K_j is the Junction Loss Coefficient determined by:

$$K_j = (Q_3/Q_1)/(1.18 + 0.63(Q_3/Q_1))$$
- Column (20) - Headwater (HW) Elevation; this is determined by combining the energy heads in Columns 17, 18, and 19 with the highest control elevation in either Column 15 or 16, as follows:

$$\text{Col.}(20) = \text{Col.}(15 \text{ or } 16) - \text{Col.}(17) + \text{Col.}(18) + \text{Col.}(19)$$

FIGURE 4.2.1.J BACKWATER PIPE CALCULATION EXAMPLE

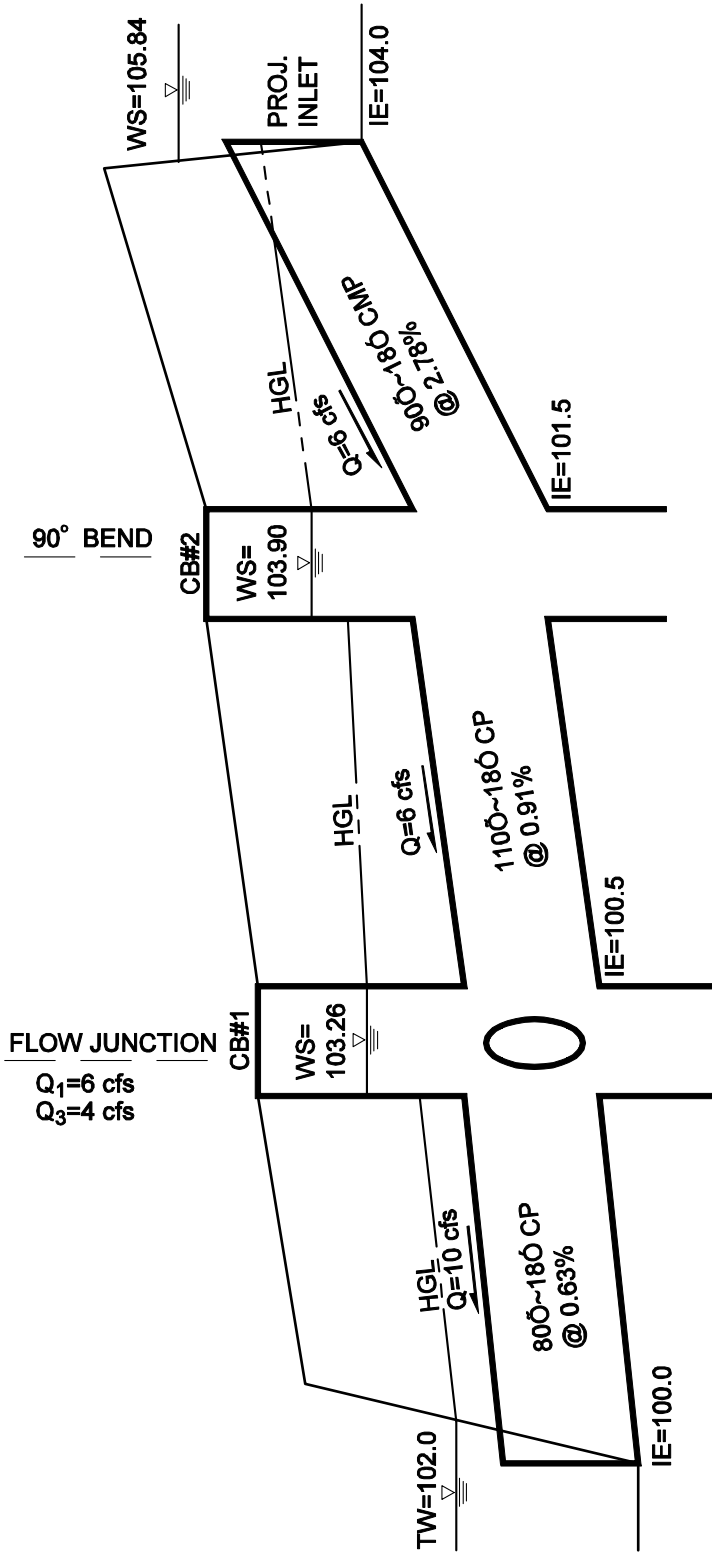

BACKWATER CALCULATION SHEET

	(1)	(2)	(3)	(4)	(5)	(6)	(7)	(8)	(9)	(10)	(11)	(12)	(13)	(14)	(15)	(16)	(17)	(18)	(19)	(20)
Pipe Segment CB to CB	Q (cfs)	Length (ft)	Pipe Size	On Value	Outlet Elev (ft)	Inlet Elev (ft)	Barrel Area (sqft)	Barrel Vel (fps)	Barrel Vel Head (ft)	TW Elev (ft)	Fric Loss (ft)	Entr HGL Elev (ft)	Entr Head Loss (ft)	Exit Head Loss (ft)	Outlet Contr Elev (ft)	Inlet Contr Elev (ft)	Appr Vel Head (ft)	Bend Head Loss (ft)	Junc Head Loss (ft)	HW Elev (ft)
1	10	80	180	0.012	100.00	100.50	1.77	5.65	0.50	102.00	0.62	102.62	0.25	0.50	103.37	102.75	-0.18	0.002	0.07	103.26
1	6	110	180	0.012	100.50	101.50	1.77	3.39	0.18	103.26	0.31	103.57	0.09	0.18	103.84	102.95	-0.18	0.24	0.0	103.90
2	6	90	180	0.024	101.50	104.00	1.77	3.39	0.18	103.90	1.00	(104.9) 105.5	0.16	0.18	105.84	105.80	-0.0	0.0	0.0	105.84

Select the greater elevation

FIGURE 4.2.1.K BEND HEAD LOSSES IN STRUCTURES

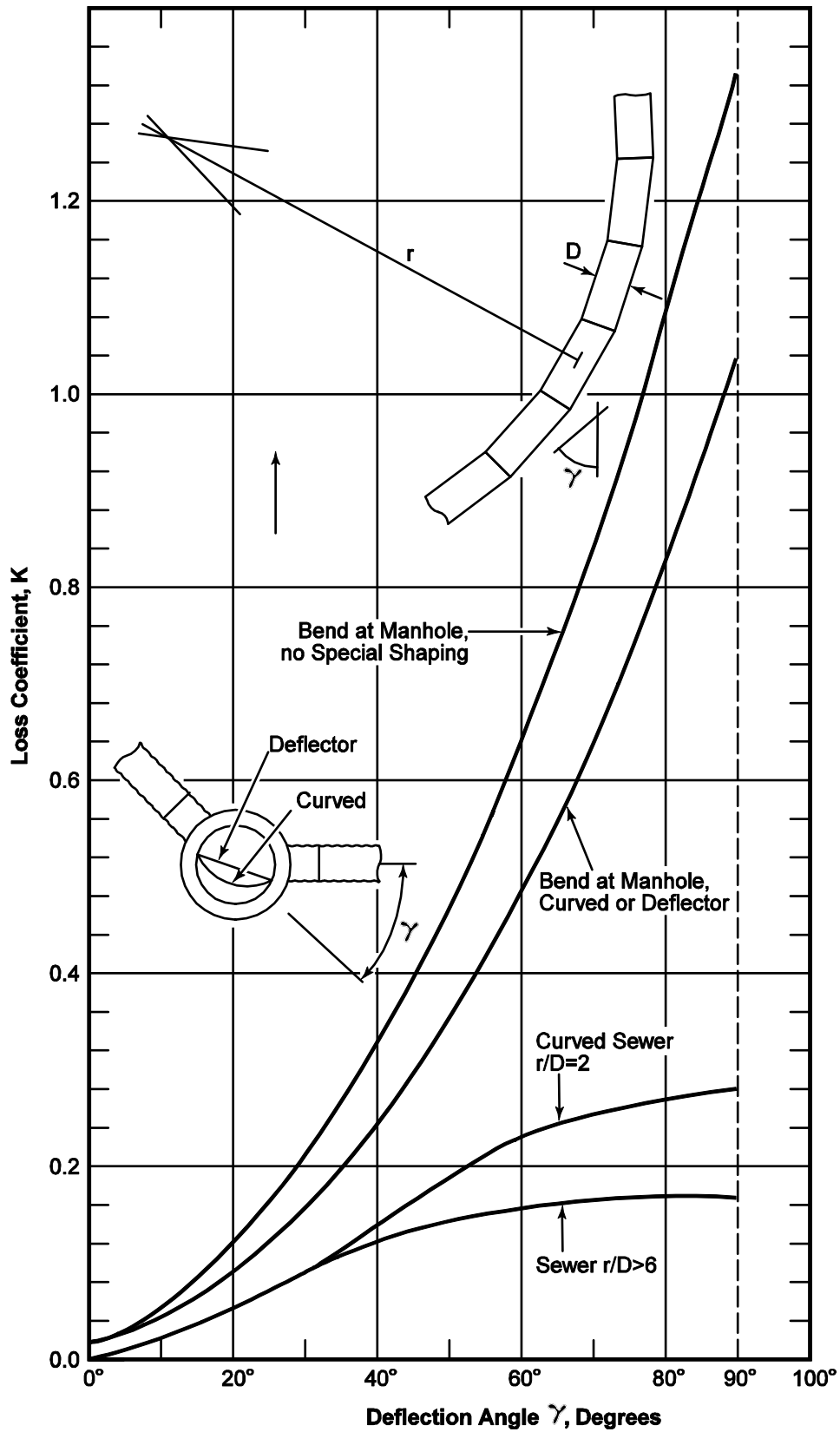
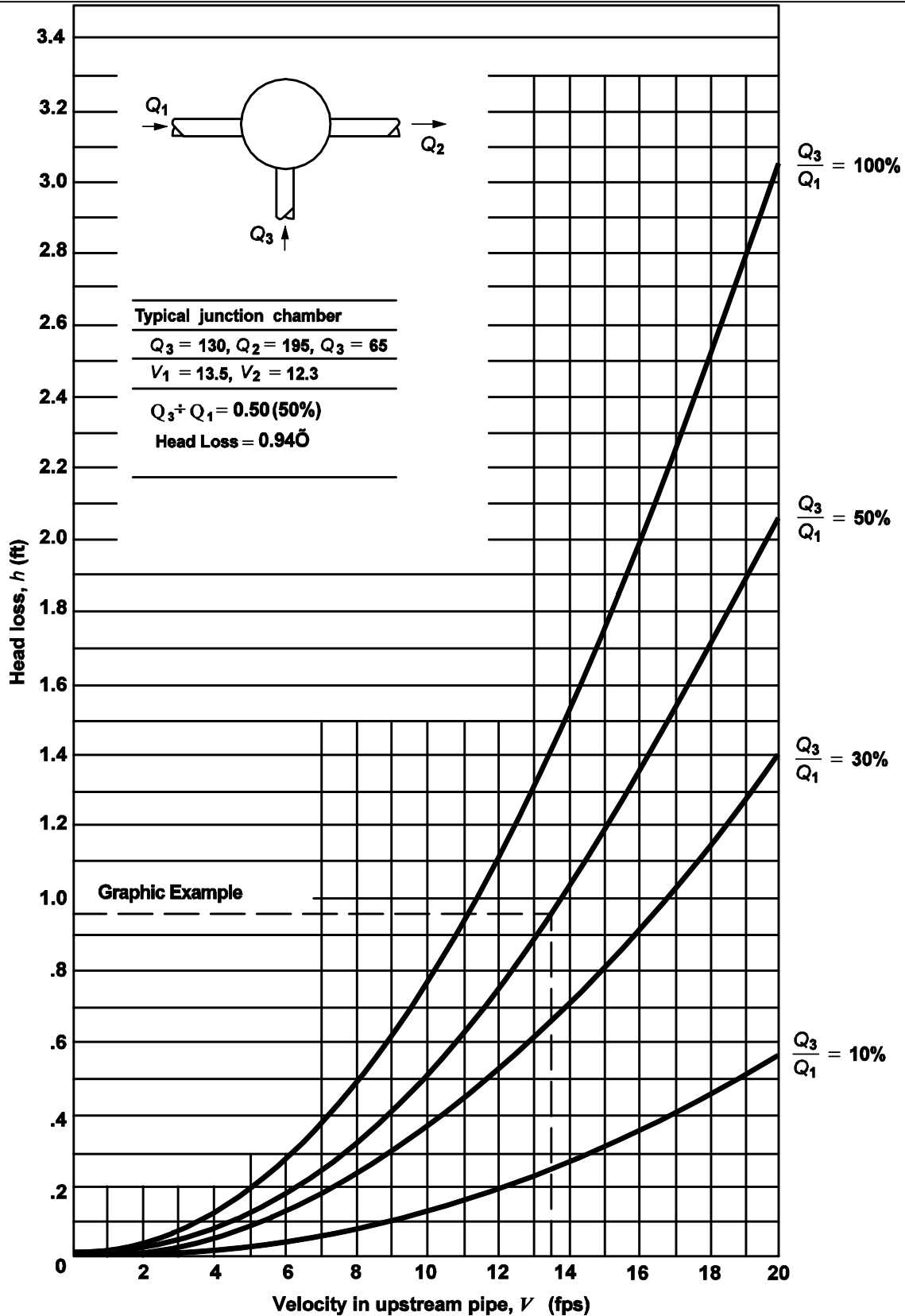

FIGURE 4.2.1.L JUNCTION HEAD LOSS IN STRUCTURES



4.2.2 OUTFALL SYSTEMS

Properly designed outfalls are critical to ensuring no adverse impacts occur as the result of concentrated discharges from pipe systems and culverts, both *onsite* and downstream. *Outfall systems* include rock splash pads, flow dispersal trenches, gabion or other energy dissipaters, and tightline systems. A *tightline system* is typically a continuous length of pipe used to convey flows down a steep or sensitive slope with appropriate energy dissipation at the discharge end. In general, it is recommended that conveyance systems be designed to reduce velocity above outfalls to the extent feasible.

4.2.2.1 DESIGN CRITERIA

General

At a minimum, all outfalls shall be provided with a **rock splash pad** (see Figure 4.2.2.A) except as specified below and in Table 4.2.2.A:

1. The **flow dispersal trench** shown in Figure 4.2.2.B shall only be used as an outfall as described in Core Requirement #1, Section 1.2.1.
2. For outfalls with a velocity at design flow greater than 10 fps, a **gabion dissipater or engineered energy dissipater** shall be required. Note the gabion outfall detail shown in Figure 4.2.2.D is illustrative only; a design engineered to specific *site* conditions is required. Gabions shall conform to WDSOT/APWA specifications.
3. **Engineered energy dissipaters**, including stilling basins, drop pools, hydraulic jump basins, baffled aprons, and bucket aprons, are required for outfalls with velocity at design flow greater than 20 fps. These should be designed using published or commonly known techniques found in such references as *Hydraulic Design of Energy Dissipaters for Culverts and Channels*, published by the Federal Highway Administration of the United States Department of Transportation; *Open Channel Flow*, by V.T. Chow; *Hydraulic Design of Stilling Basins and Energy Dissipaters*, EM 25, Bureau of Reclamation (1978); and other publications, such as those prepared by the Soil Conservation Service (now Natural Resource Conservation Service). **Alternate mechanisms**, such as bubble-up structures (which will eventually drain) and **structures** fitted with reinforced concrete posts, may require an approved adjustment and must be designed using sound hydraulic principles and considering constructability and ease of *maintenance*.
4. **Tightline systems** shall be used when required by the discharge requirements of Core Requirement #1 or the outfall requirements of Core Requirement #4. Tightline systems may also be used to prevent aggravation or creation of a downstream erosion problem.
5. **Flood closure devices** shall be provided on new outfalls passing through existing levees or other features that contain floodwaters. Such **structures** shall be designed to the *Corps of Engineers Manual for Design and Construction of Levees* (EM 1110-2-1913).
6. **Backup (secondary gate) closure devices** shall be required for new outfalls through flood containment levees unless this requirement is specifically waived by the City.
7. New **outfalls through levees along the Green River** between River Mile 6 and State Route 18 shall comply with the terms of the adopted *Lower Green River Pump Operation Procedures Plan*.

Tightline Systems

1. Outfall tightlines may be installed in trenches with standard bedding on **slopes up to 40%**. In order to minimize disturbance to **slopes greater than 40%**, it is recommended that tightlines be placed at grade with proper pipe anchorage and support.

2. Solid wall HDPE tightlines must be designed to address the material limitations, particularly **thermal expansion and contraction** and pressure design, as specified by the manufacturer. The coefficient of thermal expansion and contraction for solid wall HDPE is on the order of 0.001 inch per foot per Fahrenheit degree. **Sliding sleeve connections** shall be used to address this thermal expansion and contraction. These sleeve connections consist of a section of the appropriate length of the next larger size diameter of pipe into which the outfall pipe is fitted. These sleeve connections must be located as close to the discharge end of the outfall system as is practical.
3. Solid wall HDPE tightlines shall be designed and sized using the applicable design criteria and methods of analysis specified for pipe systems in Section 4.2.1.
4. Due to the ability of solid wall HDPE tightlines to transmit flows of very high energy, special consideration for **energy dissipation** must be made. A schematic representation of a “gabion mattress energy dissipater” has been provided as Figure 4.2.2.D . Flows of very high energy will require a specifically engineered energy dissipater structure, as described above in General Criterion #3. *Caution, the in-stream sample gabion mattress energy dissipater may not be acceptable within the ordinary high water mark of fish-bearing waters or where gabions will be subject to abrasion from upstream channel sediments. A four-sided gabion basket located outside the ordinary high water mark should be considered for these applications.*

TABLE 4.2.2.A ROCK PROTECTION AT OUTFALLS

Discharge Velocity at Design Flow (fps)		REQUIRED PROTECTION				
Greater than	Less than or equal to	Minimum Dimensions ⁽¹⁾				
		Type	Thickness	Width	Length	Height
0	5	Rock lining ⁽²⁾	1 foot	Diameter + 6 feet	8 feet or 4 x diameter, whichever is greater	Crown + 1 foot
5	10	Riprap ⁽³⁾	2 feet	Diameter + 6 feet or 3 x diameter, whichever is greater	12 feet or 4 x diameter, whichever is greater	Crown + 1 foot
10	20	Gabion outfall	As required	As required	As required	Crown + 1 foot
20	N/A	Engineered energy dissipater required				

(1) These sizes assume that erosion is dominated by outfall energy. In many cases sizing will be governed by conditions in the **receiving waters**.

(2) **Rock lining** shall be quarry spalls with gradation as follows:
 Passing 8-inch square sieve: 100%
 Passing 3-inch square sieve: 40 to 60% maximum
 Passing 3/4-inch square sieve: 0 to 10% maximum

(3) **Riprap** shall be reasonably well graded with gradation as follows:
 Maximum stone size: 24 inches (nominal diameter)
 Median stone size: 16 inches
 Minimum stone size: 4 inches

Note: Riprap sizing governed by side slopes on outlet channel is assumed to be approximately 3:1.

FIGURE 4.2.2.A SCHEMATIC REPRESENTATION OF PIPE/CULVERT DISCHARGE PROTECTION

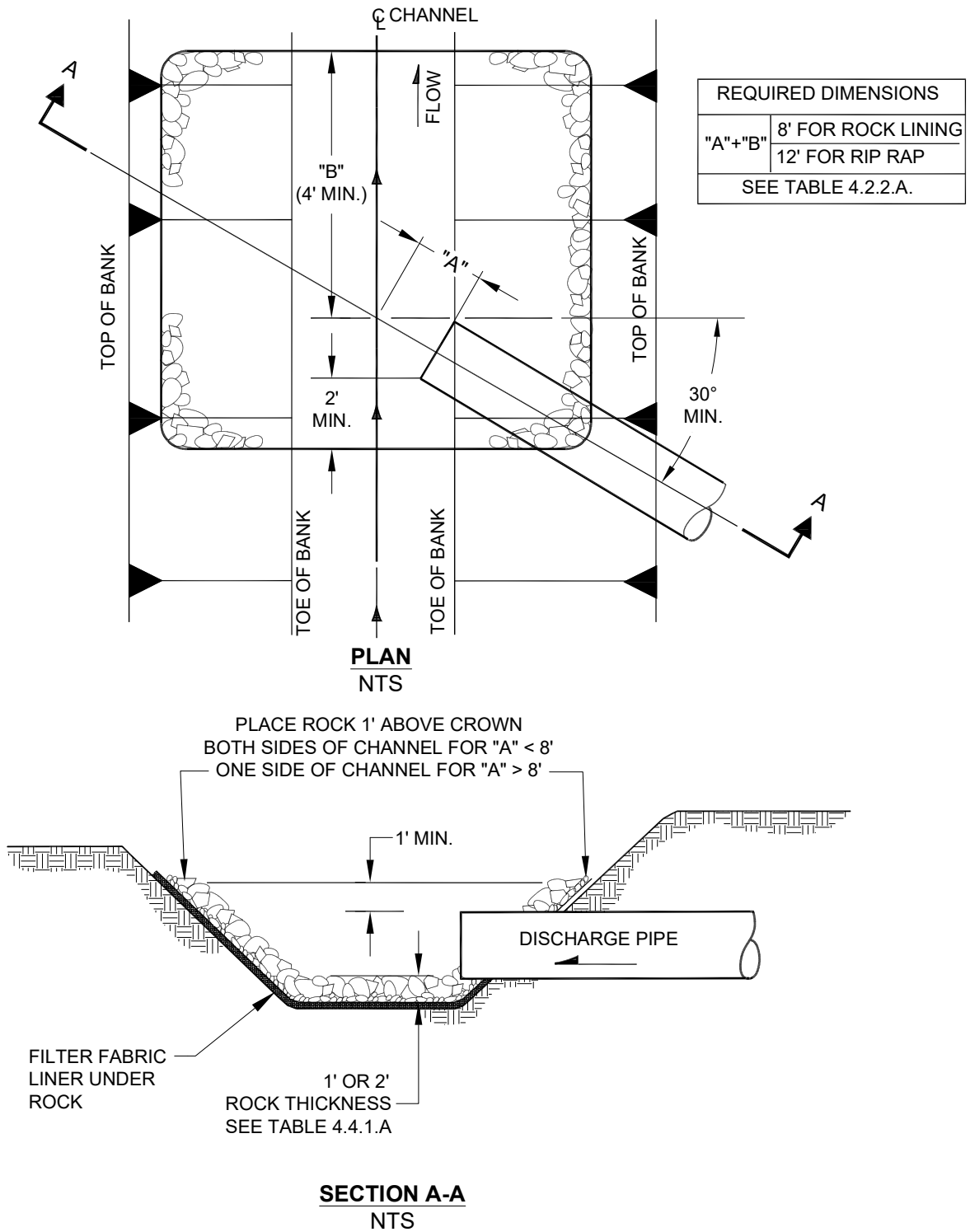

FIGURE 4.2.2.B SCHEMATIC REPRESENTATION OF A FLOW DISPERSAL TRENCH

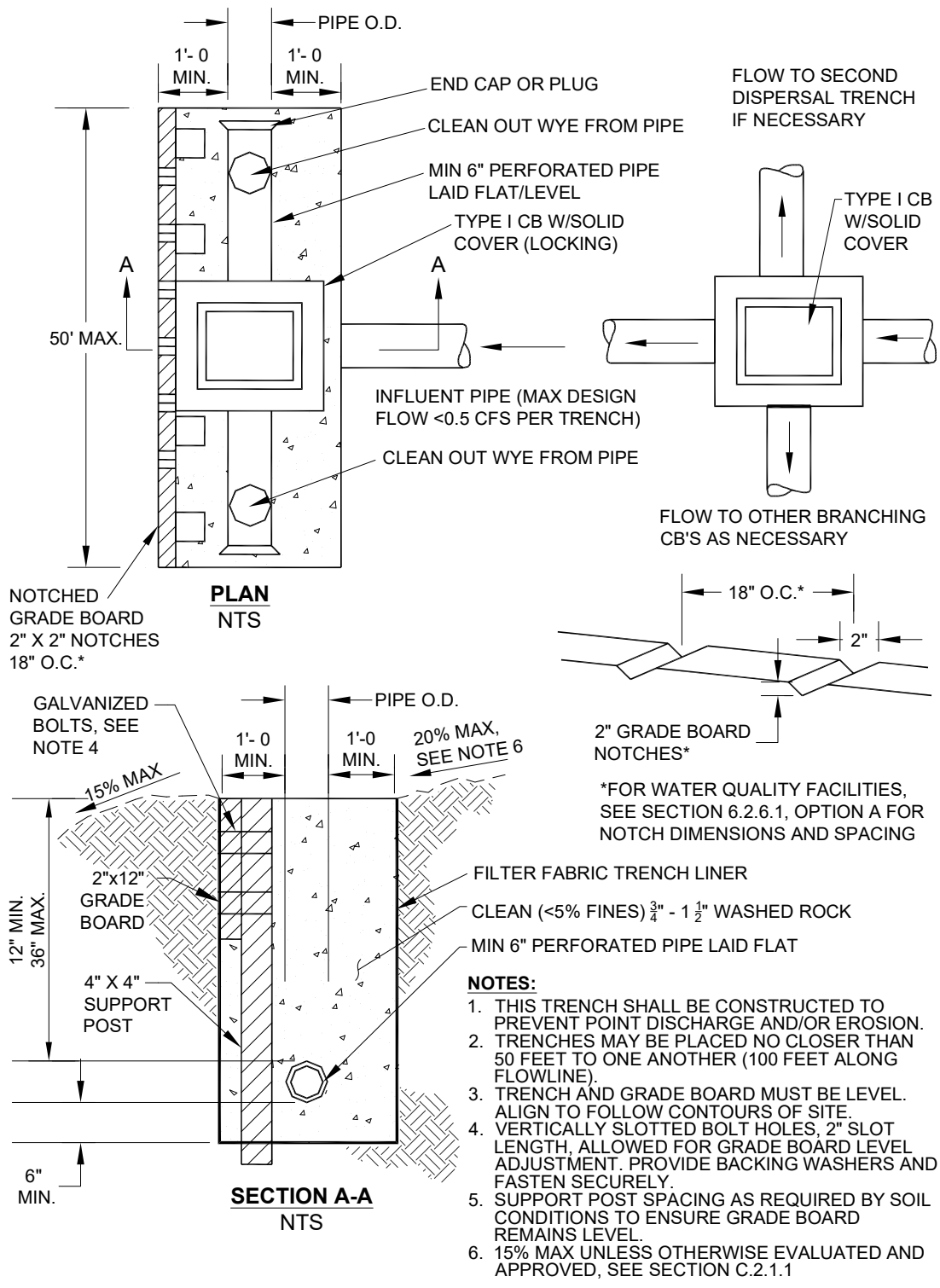
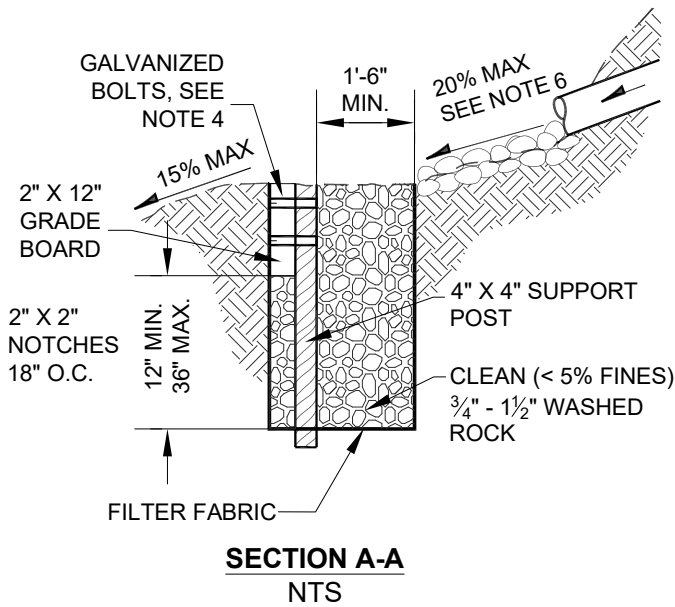

FIGURE 4.2.2.C SCHEMATIC REPRESENTATION OF AN ALTERNATIVE FLOW DISPERSAL TRENCH



NOTES:

1. THIS TRENCH SHALL BE CONSTRUCTED TO PREVENT POINT DISCHARGE AND /OR EROSION.
2. TRENCHES MAY BE PLACED NO CLOSER THAN 50 FEET TO ONE ANOTHER (100 FEET ALONG FLOWLINE).
3. TRENCH AND GRADE BOARD MUST BE LEVEL. ALIGN TO FOLLOW CONTOURS OF SITE.
4. VERTICALLY SLOTTED BOLT HOLES, 2" SLOT LENGTH, ALLOWED FOR GRADE BOARD LEVEL ADJUSTMENT. PROVIDE BACKING WASHERS AND FASTEN SECURELY.
5. PROVIDE SUPPORT POST SPACING AS REQUIRED BY SOIL CONDITIONS TO ENSURE GRADE BOARD REMAINS LEVEL.
6. 15% MAX UNLESS OTHERWISE EVALUATED AND APPROVED, SEE SECTION C.2.1.1

*FOR WATER QUALITY FACILITIES, SEE SECTION 6.2.6.1, OPTION A FOR NOTCH DIMENSIONS AND SPACING

NOTCH DETAIL
NTS

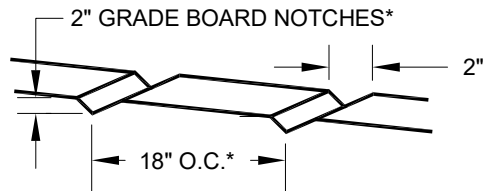
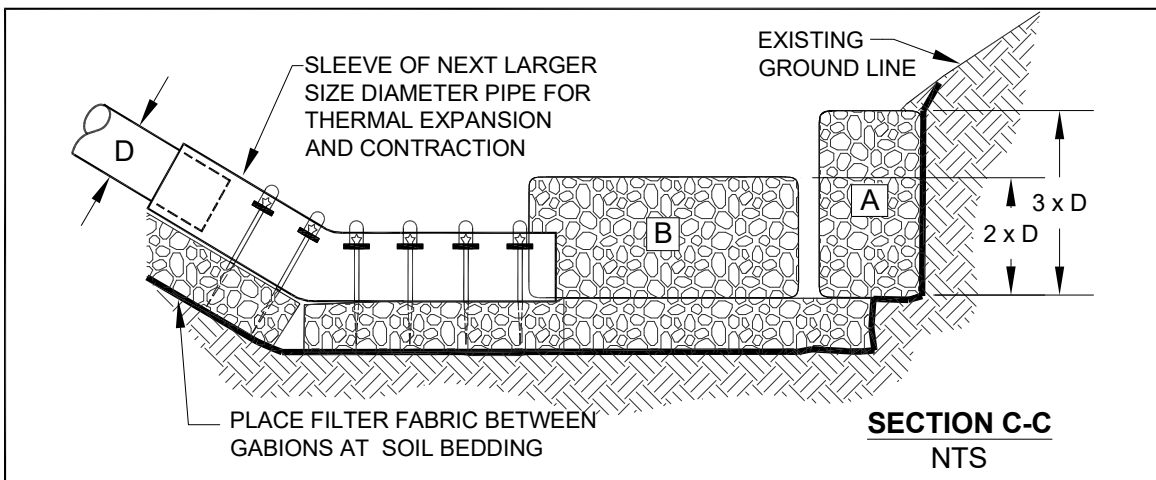
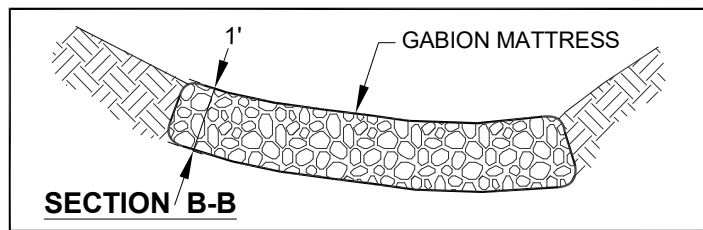
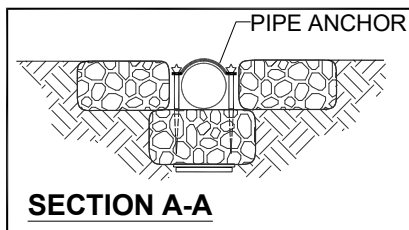
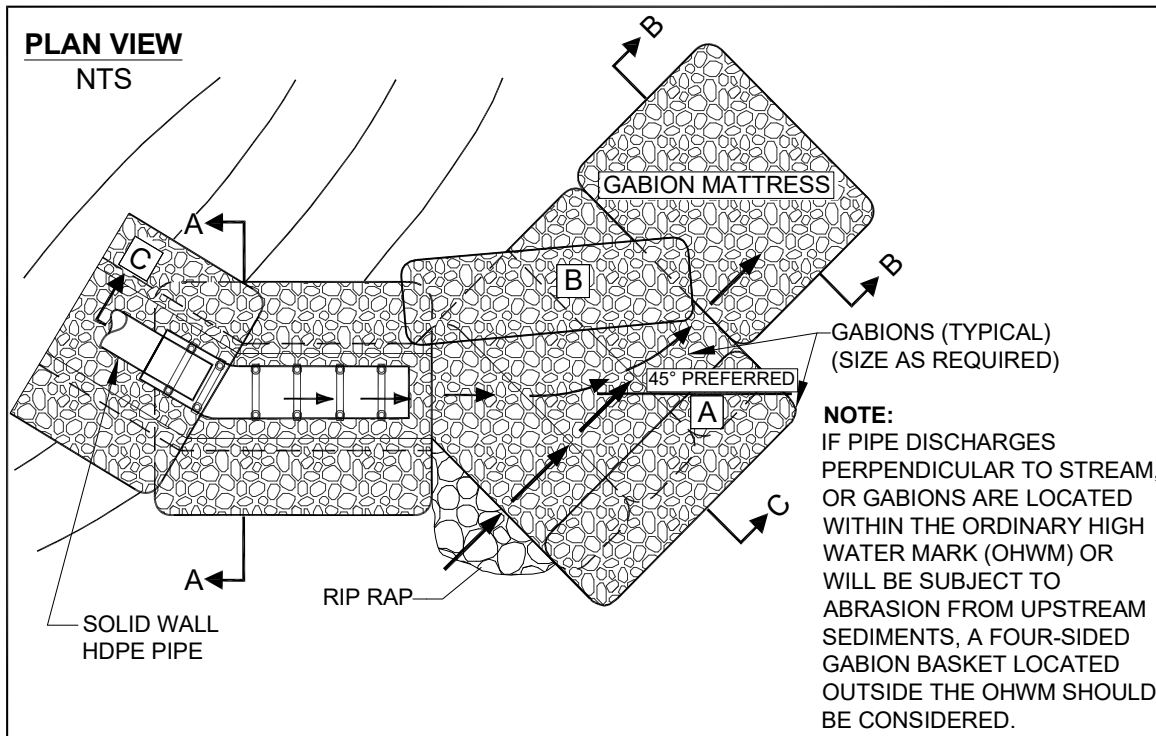

FIGURE 4.2.2.D SCHEMATIC REPRESENTATION OF A GABION MATTRESS ENERGY DISSIPATOR



4.2.3 PUMP SYSTEMS

As allowed in Core Requirement #4, Section 1.2.4.3, pump systems may be used for conveyance of flows internal to a *site* if located on private property and privately maintained. Pump systems discharging to the Green River between River Mile 6 and State Route 18 (within the Green River Flood Control Zone District) shall comply with the standards of the adopted *Green River Pump Operation Procedures Plan*.

4.2.3.1 DESIGN CRITERIA

Proposed pump systems must meet the following minimum requirements:

1. The pump system must be **privately owned and maintained**.
2. The pump system shall be used to convey water from one location or elevation to another within the *site*.
3. The pump system must have a dual pump (alternating) equipped with an external alarm system.
4. The pump system shall not be used to circumvent any other City drainage requirements, and construction and operation of the pump system shall not violate any other City requirements.
5. The gravity-flow components of the drainage system to and from the pump system must be designed so that pump failure does not result in flooding of a building or emergency access, or overflow to a location other than the *natural discharge point* for the *site*.
6. The pump system shall have either installed emergency backup power or the ability for portable backup power generator in the event of a loss of primary power. If portable backup emergency power is provided, the appliance must include a description of how the backup power will be brought to the *site* during an emergency within an emergency response plan (discussed below).
7. The applicant must provide an emergency response plan that details how backup power will be activated during an emergency and include method for delivering to the *site* and energizing portable backup power. The emergency response plan must also describe response for pump failures including repair and replacement of damaged pumps/motors and generators.

4.2.3.2 METHODS OF ANALYSIS

Pump systems must be sized in accordance with the conveyance capacity requirements for pipe systems set forth in Section 1.2.4, “Core Requirement #4: Conveyance System.”

4.3 CULVERTS AND BRIDGES

This section presents the methods, criteria, and details for hydraulic analysis and design of culverts and bridges. The information presented is organized as follows:

- Section 4.3.1, “Culverts”
 - “Design Criteria,” Section 4.3.1.1
 - “Methods of Analysis,” Section 4.3.1.2
- Section 4.3.2, “Culverts Providing for Fish Passage/Migration”
 - “Design Criteria,” Section 4.3.2.1
 - “Methods of Analysis,” Section 4.3.2.2
- Section 4.3.3, “Bridges”
 - “Design Criteria,” Section 4.3.3.1
 - “Methods of Analysis,” Section 4.3.3.2.

4.3.1 CULVERTS

Culverts are relatively short segments of pipe of circular, elliptical, rectangular, or arch cross section. They are usually placed under road embankments or driveways to convey surface water flow safely under the embankment. They may be used to convey flow from constructed or natural channels including streams. The Critical Areas Code (RMC 4-3-050) contains definitions of streams (termed “aquatic areas”) and requirements for crossing of streams. In addition to those requirements and the design criteria described below, other agencies such as the Washington State Department of Fish and Wildlife (WDFW) may have additional requirements affecting the design of proposed culverts.

4.3.1.1 DESIGN CRITERIA

General

In addition to the design criteria described below, culverts shall be designed to meet the hydraulic criteria as described in Section 1.2.4.1.

1. All **circular pipe culverts** shall conform to any applicable design criteria specified for pipe systems in Section 4.2.1.
2. All **other types** of culverts shall conform to manufacturer's specifications. See the *City of Renton Standard Details* for types of culverts allowed in City right-of-way.

Headwater

1. For **culverts 18-inch diameter or less**, the maximum allowable headwater elevation (measured from the inlet invert) shall not exceed 2 times the pipe diameter or arch-culvert-rise at *design flow* (i.e., the 10-year or 25-year peak flow rate as specified in Core Requirement #4, Section 1.2.4).
2. For **culverts larger than 18-inch diameter**, the maximum allowable design flow headwater elevation (measured from the inlet invert) shall not exceed 1.5 times the pipe diameter or arch-culvert-rise at design flow.
3. The **maximum headwater elevation** at design flow shall be below any road or parking lot subgrade.

Inlets and Outlets

1. All inlets and outlets in or near roadway embankments must be flush with and conforming to the slope of the embankment.
2. For culverts 18-inch diameter and larger, the embankment around the culvert inlet shall be protected from erosion by **rock lining or riprap** as specified in Table 4.2.2.A, except the length shall extend at least 5 feet upstream of the culvert, and the height shall be at or above the design headwater elevation.
3. **Inlet structures**, such as concrete headwalls, may provide a more economical design by allowing the use of smaller entrance coefficients and, hence, smaller diameter culverts. When properly designed, they will also protect the embankment from erosion and eliminate the need for rock lining.
4. In order to maintain the stability of roadway embankments, concrete headwalls, wingwalls, or tapered inlets and outlets may be required if **right-of-way or easement constraints** prohibit the culvert from extending to the toe of the embankment slopes. All inlet **structures** or headwalls installed in or near roadway embankments must be flush with and conforming to the slope of the embankment.
5. **Debris barriers (trash racks)** are required on the inlets of all culverts that are over 60 feet in length and are 18 to 36 inches in diameter. Debris barriers for pipes smaller than 18 inches and larger than 36 inches in diameter may be required depending on conditions and safety concerns. Debris barriers shall have a bar spacing of 6 inches. This requirement also applies to the inlets of pipe systems. See Figure 4.2.1.D and Figure 4.2.1.E for schematic representations of debris barriers.
6. For culverts 18-inch diameter and larger, the receiving channel of the outlet shall be protected from erosion by **rock lining** specified in Table 4.2.2.A, except the height shall be one foot above maximum tailwater elevation or one foot above the crown, whichever is higher (See Figure 4.2.2.A).

4.3.1.2 METHODS OF ANALYSIS

This section presents the methods of analysis for designing new or evaluating existing **culverts** for compliance with the conveyance capacity requirements set forth in Section 1.2.4, “Core Requirement #4: Conveyance System.”

DESIGN FLOWS

Design flows for sizing or assessing the capacity of culverts shall be determined using the hydrologic analysis methods described in Chapter 3.

CONVEYANCE CAPACITY

The theoretical analysis of culvert capacity can be extremely complex because of the wide range of possible flow conditions that can occur due to various combinations of inlet and outlet submergence and flow regime within the culvert barrel. An exact analysis usually involves detailed backwater calculations, energy and momentum balance, and application of the results of hydraulic model studies.

However, simple procedures have been developed where the various flow conditions are classified and analyzed on the basis of a control section. A *control section* is a location where there is a unique relationship between the flow rate and the upstream water surface elevation. Many different flow conditions exist over time, but at any given time the flow is either governed by the culvert's inlet geometry (*inlet control*) or by a combination of inlet geometry, barrel characteristics, and tailwater elevation (*outlet control*). Figure 4.3.1.A illustrates typical conditions of inlet and outlet control. The procedures presented in this section provide for the analysis of both inlet and outlet control conditions to determine which governs.

Inlet Control Analysis

Nomographs such as those provided in Figure 4.3.1.B and Figure 4.3.1.C may be used to determine the **inlet control headwater depth** at design flow for various types of culverts and inlet configurations. These nomographs were originally developed by the Bureau of Public Roads—now the Federal Highway Administration (FHWA)—based on their studies of culvert hydraulics. These and other nomographs can be found in the FHWA publication *Hydraulic Design of Highway Culverts, HDS No. #5 (Report No. FHWA-IP-85-15)* (September 1985), or the *WSDOT Hydraulic Manual*.

Also available in the FHWA publication, are the design equations used to develop the inlet control nomographs. These equations are presented below.

For **unsubmerged** inlet conditions (defined by $Q/AD^{0.5} \leq 3.5$);

$$\text{Form 1*}: HW/D = H_c/D + K(Q/AD^{0.5})^M - 0.5S^{**} \quad (4-3)$$

$$\text{Form 2*}: HW/D = K(Q/AD^{0.5})^M \quad (4-4)$$

For **submerged** inlet conditions (defined by $Q/AD^{0.5} \geq 4.0$);

$$HW/D = c(Q/AD^{0.5})^2 + Y - 0.5S^{**} \quad (4-5)$$

where

- HW = headwater depth above inlet invert (ft)
- D = interior height of culvert barrel (ft)
- H_c = specific head (ft) at critical depth ($d_c + V_c^2/2g$)
- Q = flow (cfs)
- A = full cross-sectional area of culvert barrel (sf)
- S = culvert barrel slope (ft/ft)
- K, M, c, Y = constants from Table 4.3.1.A.

The specified head H_c is determined by the following equation:

$$H_c = d_c + V_c^2/2g \quad (4-6)$$

where

- d_c = critical depth (ft); see Figure 4.3.1.F
- V_c = flow velocity at critical depth (fps)
- g = acceleration due to gravity (32.2 ft/sec²).

* The appropriate equation form for various inlet types is specified in Table 4.3.1.A below.

** For mitered inlets, use +0.7S instead of -0.5S.

Note: Between the unsubmerged and submerged conditions, there is a transition zone ($3.5 < Q/AD^{0.5} < 4.0$) for which there is only limited hydraulic study information. The transition zone is defined empirically by drawing a curve between and tangent to the curves defined by the unsubmerged and submerged equations. In most cases, the transition zone is short and the curve is easily constructed.

TABLE 4.3.1.A CONSTANTS FOR INLET CONTROL EQUATIONS*

Shape and Material	Inlet Edge Description	Unsubmerged			Submerged	
		Equation Form	K	M	c	Y
Circular Concrete	Square edge with headwall	1	0.0098	2.0	0.0398	0.67
	Groove end with headwall		0.0078	2.0	0.0292	0.74
	Groove end projecting		0.0045	2.0	0.0317	0.69
Circular Corrugated Steel Pipe	Headwall	1	0.0078	2.0	0.0379	0.69
	Mitered to slope		0.0210	1.33	0.0463	0.75
	Projecting		0.0340	1.50	0.0553	0.54
Rectangular Box	30° to 75° wingwall flares	1	0.026	1.0	0.0385	0.81
	90° and 15° wingwall flares		0.061	0.75	0.0400	0.80
	0° wingwall flares		0.061	0.75	0.0423	0.82
CM Boxes	90° headwall	1	0.0083	2.0	0.0379	0.69
	Thick wall projecting		0.0145	1.75	0.0419	0.64
	Thin wall projecting		0.0340	1.5	0.0496	0.57
Arch Corrugated Steel Pipe	90° headwall	1	0.0083	2.0	0.0496	0.57
	Mitered to slope		0.0300	1.0	0.0463	0.75
	Projecting		0.0340	1.5	0.0496	0.53
Bottomless Arch	90° headwall	1	0.0083	2.0	0.0379	0.69
Corrugated Steel Pipe	Mitered to slope		0.0300	2.0	0.0463	0.75
	Thin wall projecting		0.0340	1.5	0.0496	0.57
Circular with	Smooth tapered inlet throat	2	0.534	0.333	0.0196	0.89
Tapered Inlet	Rough tapered inlet throat		0.519	0.64	0.0289	0.90

* Source: FHWA HDS No. 5

Outlet Control Analysis

Nomographs such as those provided in Figure 4.3.1.D and Figure 4.3.1.E may be used to determine the **outlet control headwater depth** at design flow for various types of culverts and inlets. Outlet control nomographs other than those provided can be found in *FHWA HDS No.5* or the *WSDOT Hydraulic Manual*.

The outlet control headwater depth may also be determined using the simple Backwater Analysis method presented in Section 4.2.1.2 for analyzing pipe system capacity. This procedure is summarized as follows for culverts:

$$HW = H + TW - LS \quad (4-7)$$

where $H = H_f + H_e + H_{ex}$

$$H_f = \text{friction loss (ft)} = (V^2 n^2 L) / (2.22 R^{1.33})$$

Note: If $(H_f + TW - LS) < D$, adjust H_f such that $(H_f + TW - LS) = D$. This will keep the analysis simple and still yield reasonable results (erring on the conservative side).

$$H_e = \text{entrance head loss (ft)} = K_e (V^2 / 2g)$$

$$H_{ex} = \text{exit head loss (ft)} = V^2 / 2g$$

TW = tailwater depth above invert of culvert outlet (ft)

Note: If $TW < (D+d_c)/2$, set $TW = (D+d_c)/2$. This will keep the analysis simple and still yield reasonable results.

L = length of culvert (ft)

S = slope of culvert barrel (ft/ft)

D = interior height of culvert barrel (ft)

V = barrel velocity (fps)

n = Manning's roughness coefficient from Table 4.2.1.D

R = hydraulic radius (ft)

K_e = entrance loss coefficient (from Table 4.3.1.B)

g = acceleration due to gravity (32.2 ft/sec²)

d_c = critical depth (ft); see Figure 4.3.1.F

Note: The above procedure should not be used to develop stage/discharge curves for level pool routing purposes because its results are not precise for flow conditions where the hydraulic grade line falls significantly below the culvert crown (i.e., less than full flow conditions).

TABLE 4.3.1.B ENTRANCE LOSS COEFFICIENTS

Type of Structure and Design Entrance	Coefficient, K_e
<u>Pipe, Concrete, PVC, Spiral Rib, DI, and Lined CPE</u>	
Projecting from fill, socket (bell) end	0.2
Projecting from fill, square cut end	0.5
Headwall, or headwall and wingwalls	
Socket end of pipe (groove-end)	0.2
Square-edge	0.5
Rounded (radius = $1/12D$)	0.2
Mitered to conform to fill slope	0.7
End section conforming to fill slope*	0.5
Beveled edges, 33.7° or 45° bevels	0.2
Side- or slope-tapered inlet	0.2
<u>Pipe, or Pipe-Arch, Corrugated Metal and Other Non-Concrete or D.I.</u>	
Projecting from fill (no headwall)	0.9
Headwall, or headwall and wingwalls (square-edge)	0.5
Mitered to conform to fill slope (paved or unpaved slope)	0.7
End section conforming to fill slope*	0.5
Beveled edges, 33.7° or 45° bevels	0.2
Side- or slope-tapered inlet	0.2
<u>Box, Reinforced Concrete</u>	
Headwall parallel to embankment (no wingwalls)	
Square-edged on 3 edges	0.5
Rounded on 3 edges to radius of $1/12$ barrel dimension or beveled edges on 3 sides	0.2
Wingwalls at 30° to 75° to barrel	
Square-edged at crown	0.4
Crown edge rounded to radius of $1/12$ barrel dimension or beveled top edge	0.2
Wingwall at 10° to 25° to barrel	
Square-edged at crown	0.5
Wingwalls parallel (extension of sides)	
Square-edged at crown	0.7
Side- or slope-tapered inlet	0.2
* Note: "End section conforming to fill slope" are the sections commonly available from manufacturers. From limited hydraulic tests they are equivalent in operation to a headwall in both inlet and outlet control . Some end sections incorporating a closed taper in their design have a superior hydraulic performance.	

Computer Applications

The "King County Backwater" (KCBW) computer program available with this manual contains two subroutines (**BWPIPE** and **BWCULV**) that may be used to analyze culvert capacity and develop stage/discharge curves for level pool routing purposes. A schematic description of the nomenclature used in these subroutines is provided in Figure 4.3.1.G. The KCBW program documentation available from King County Department of Natural Resources and Parks (DNRP) includes more detailed descriptions of program features.

FIGURE 4.3.1.A INLET/OUTLET CONTROL CONDITIONS

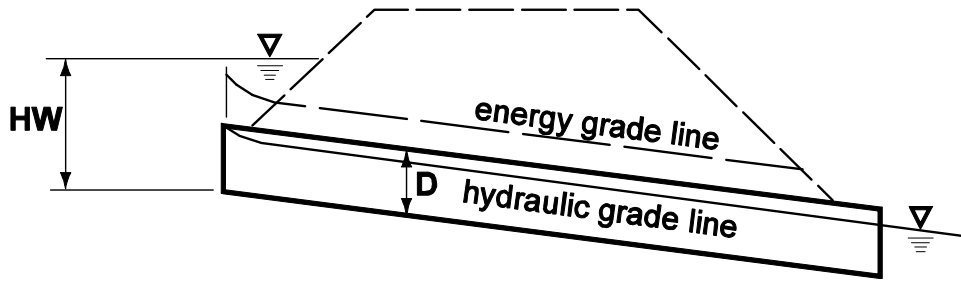

Inlet Control - Submerged Inlet

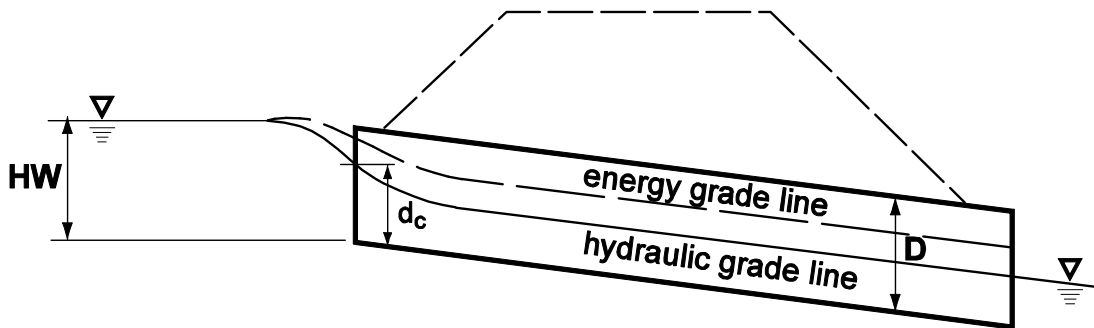

Inlet Control - Unsubmerged Inlet

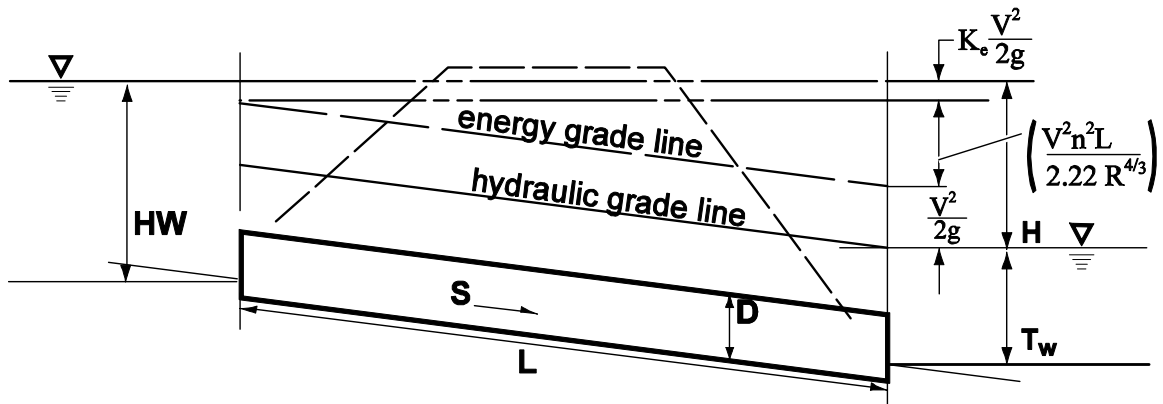

Outlet Control - Submerged Inlet and Outlet

NOTE: See FHWA no. 5 for other possible conditions

**FIGURE 4.3.1.B
HEADWATER DEPTH FOR SMOOTH INTERIOR PIPE CULVERTS WITH INLET CONTROL**

CHART 1B

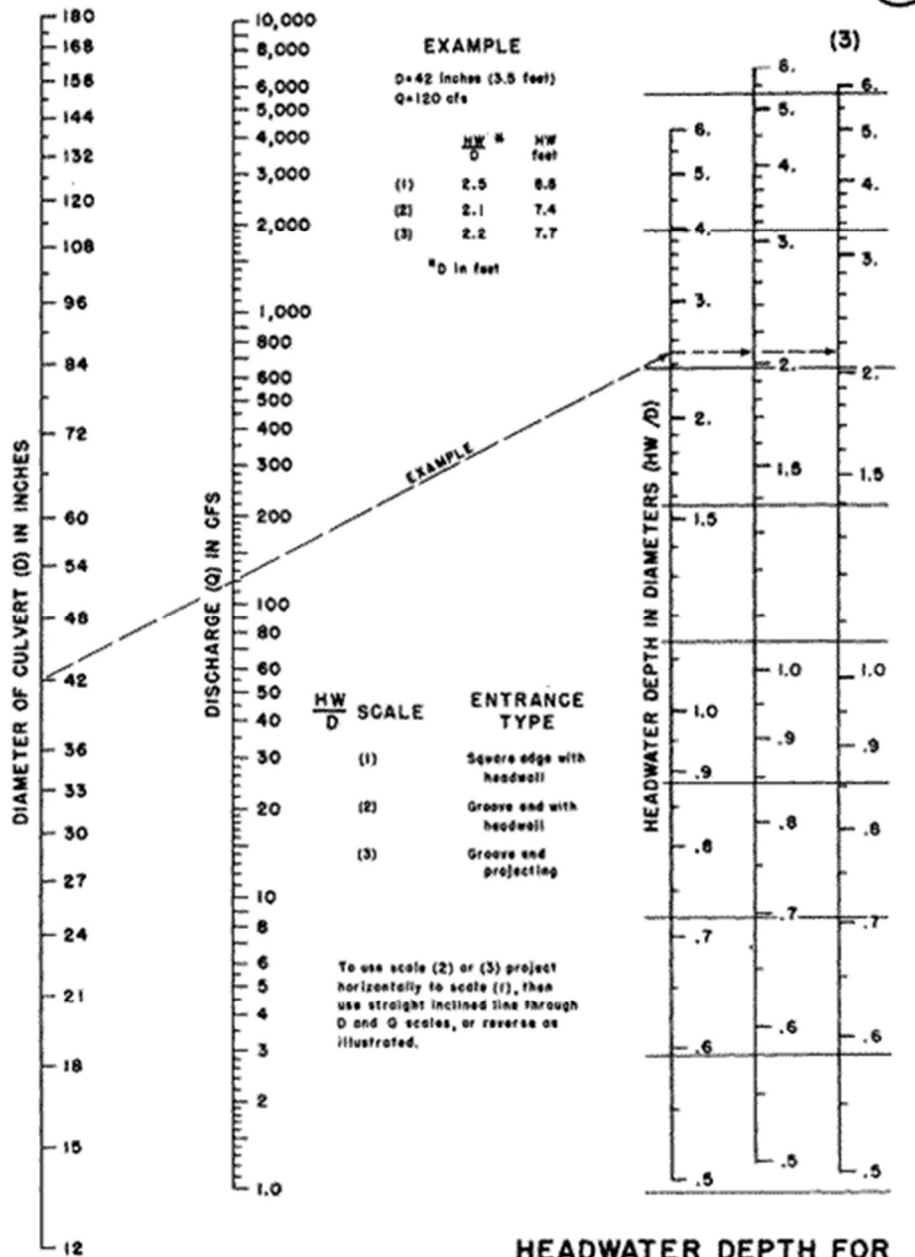

**HEADWATER DEPTH FOR
CONCRETE PIPE CULVERTS
WITH INLET CONTROL**

HEADWATER SCALES 2 & 3
REVISED MAY 1964

BUREAU OF PUBLIC ROADS JAN. 1963

FIGURE 4.3.1.C HEADWATER DEPTH FOR CORRUGATED PIPE CULVERTS WITH INLET CONTROL

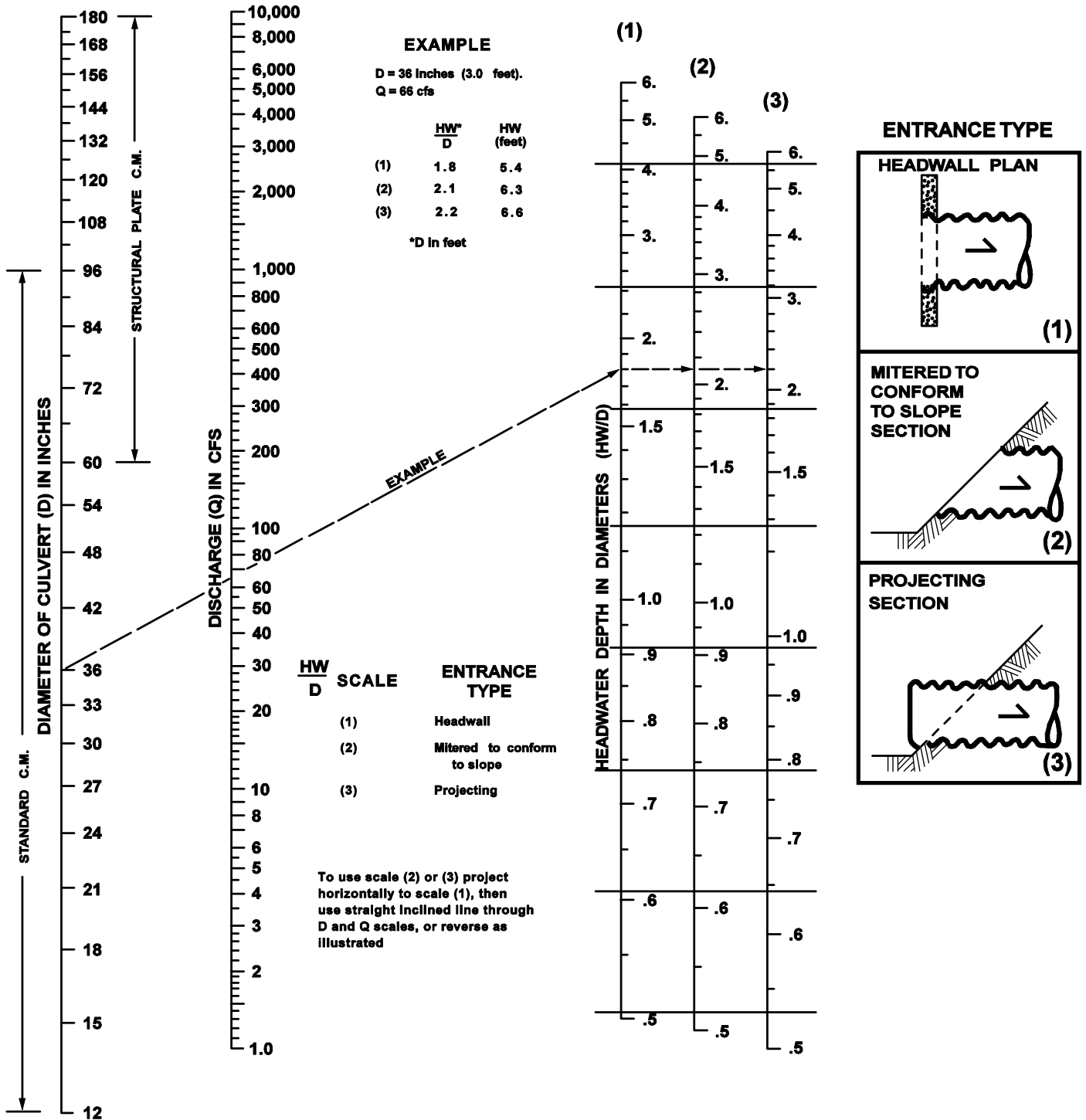

**FIGURE 4.3.1.D HEAD FOR CULVERTS (PIPE W/“n”= 0.012)
FLOWING FULL WITH OUTLET CONTROL**

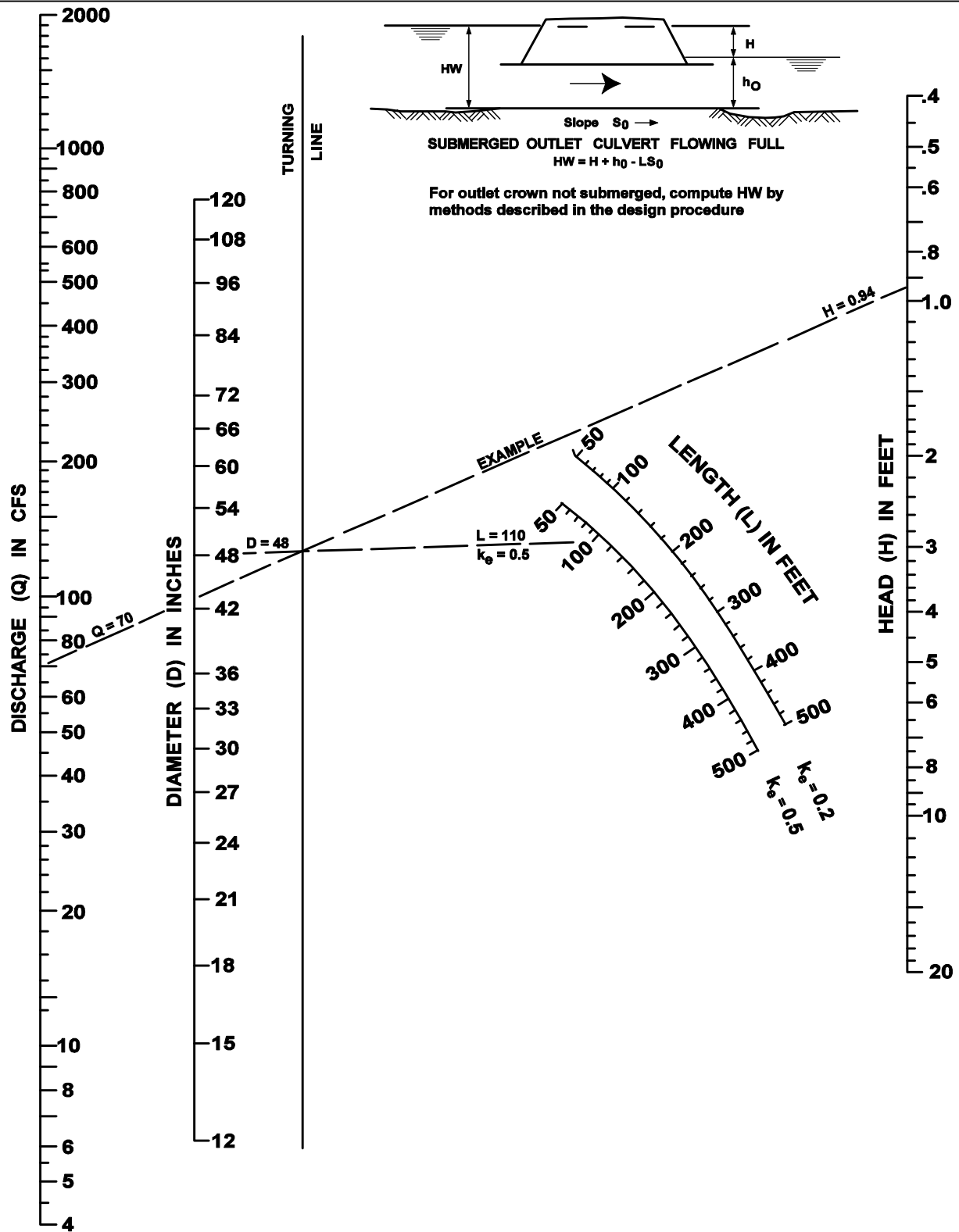

**FIGURE 4.3.1.E HEAD FOR CULVERTS (PIPE W/“n”= 0.024)
FLOWING FULL WITH OUTLET CONTROL**

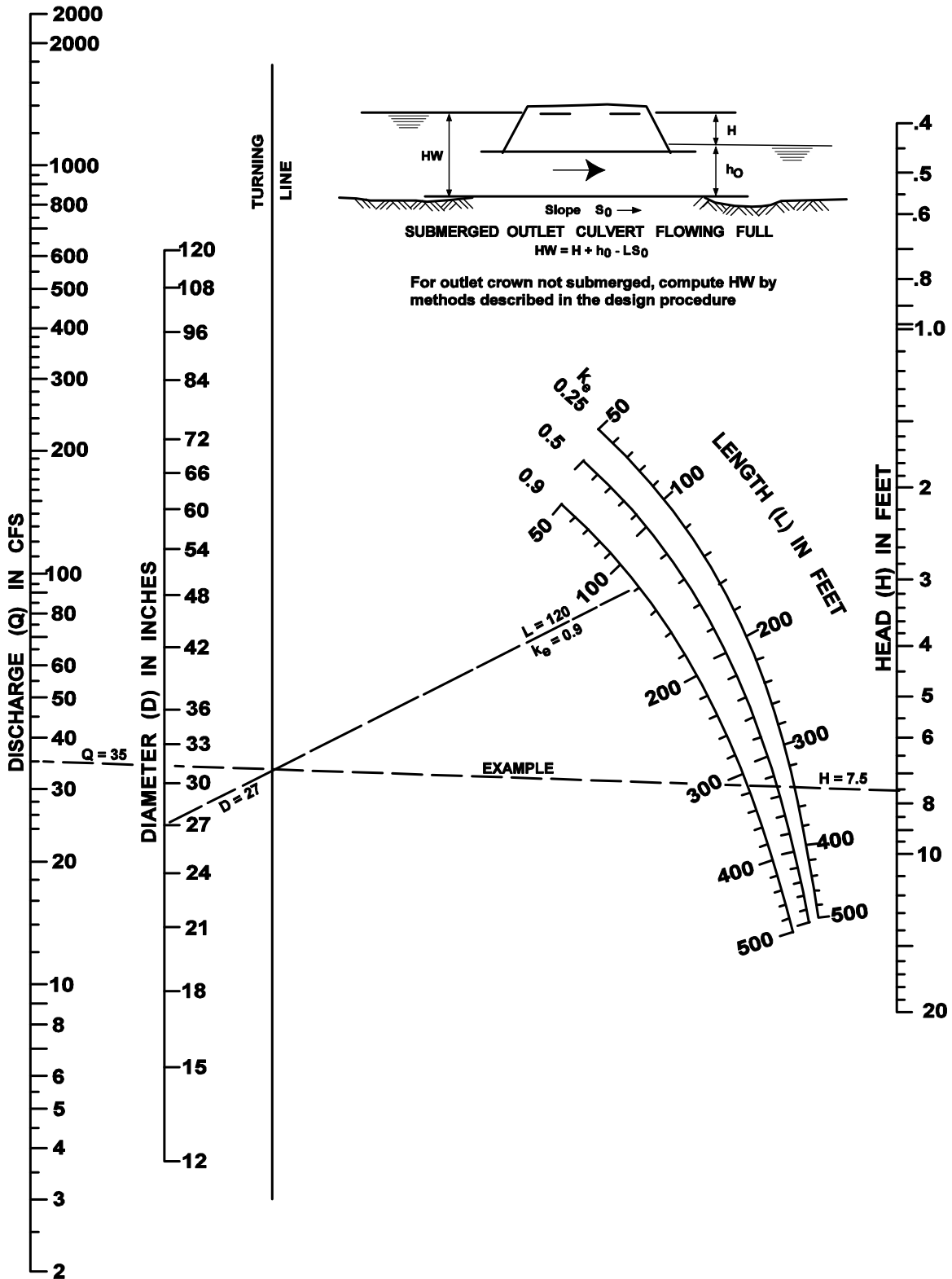
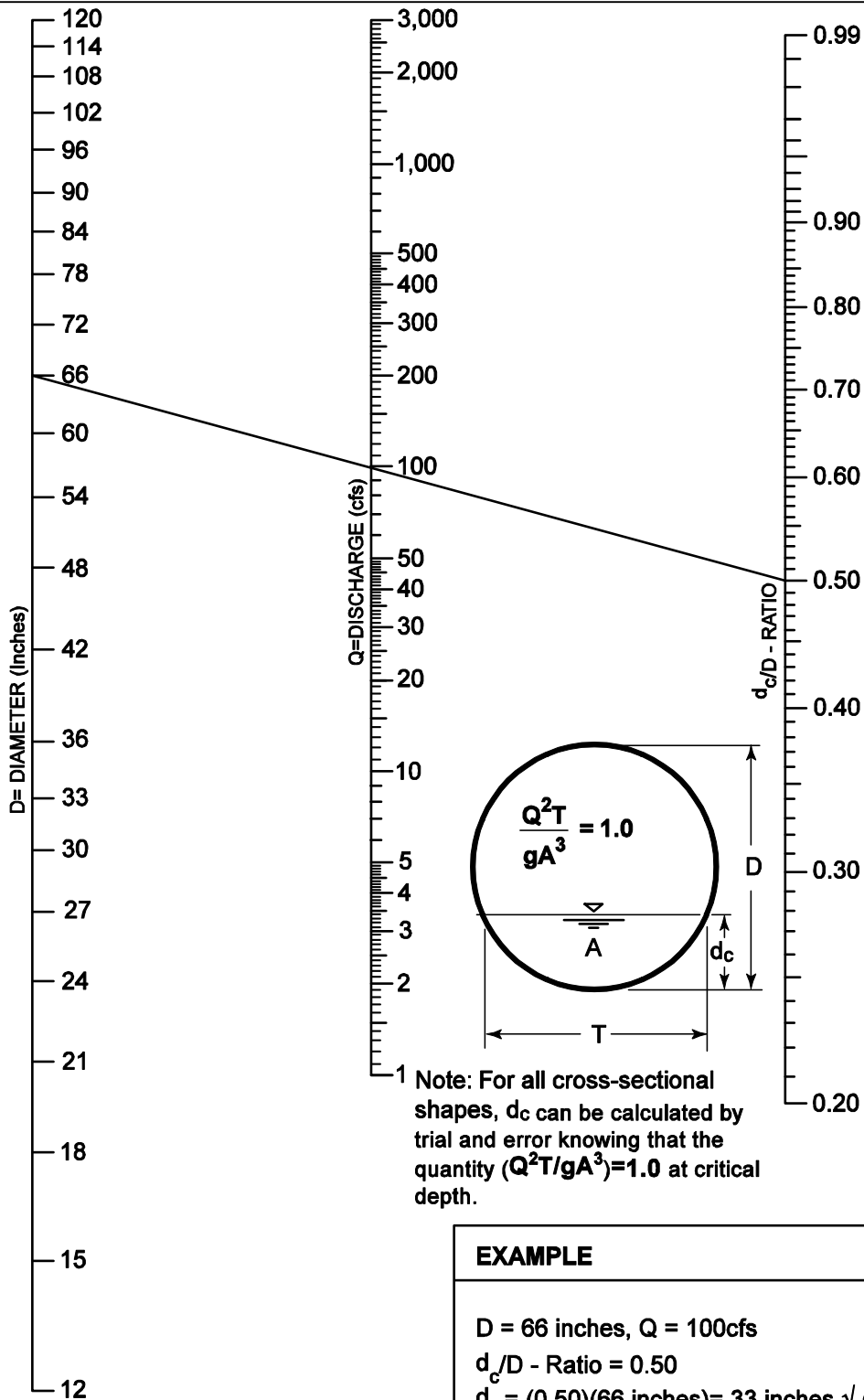
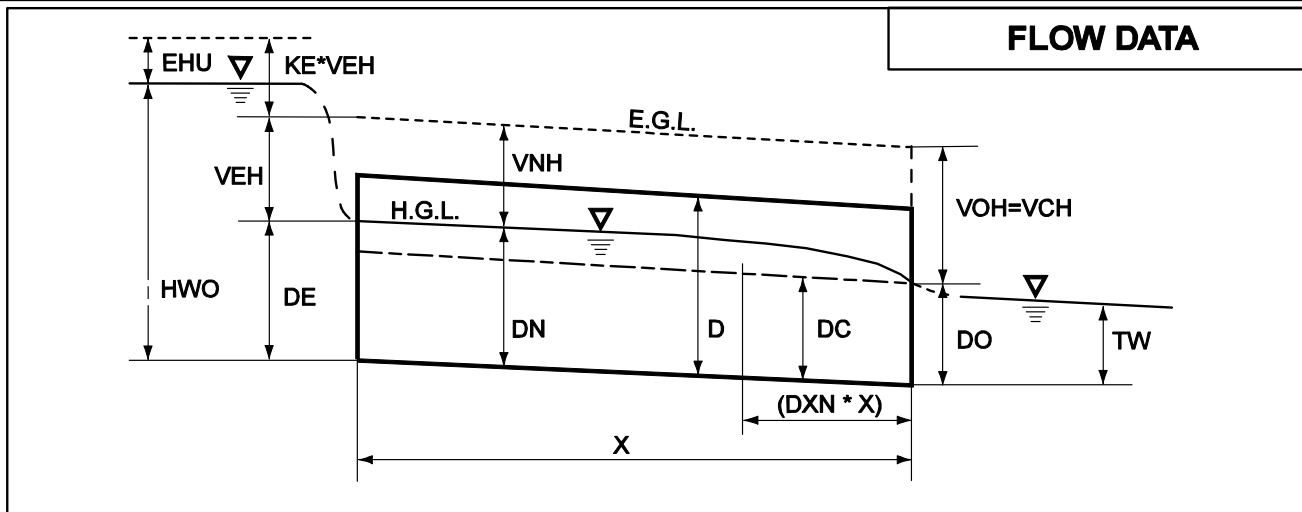

FIGURE 4.3.1.F CRITICAL DEPTH OF FLOW FOR CIRCULAR CULVERTS



EXAMPLE

D = 66 inches, Q = 100cfs
 d_c/D - Ratio = 0.50
 $d_c = (0.50)(66 \text{ inches})= 33 \text{ inches} \sqrt{(12 \text{ inches/ft})}$
 $d_c = 2.75 \text{ feet}$

FIGURE 4.3.1.G COMPUTER SUBROUTINES BWPIPE AND BWCULV: VARIABLE DEFINITIONS

FLOW DATA

DC -	Critical Depth (ft)
DN -	Normal Depth (ft)
TW -	Tailwater Depth (ft)
DO -	Outlet Depth (ft)
DE -	Entrance Depth (ft)
HWO -	Headwater (ft) assuming Outlet Control
HWI -	Headwater (ft) assuming Inlet Control
DXN -	Distance (expressed as a fraction of the pipe length) from the outlet to where the flow profile intersects with normal depth. DXN will equal one under full-flow conditions and will equal zero when a hydraulic jump occurs at the outlet or when normal depth equals zero (normal depth will equal zero when the pipe grade is flat or reversed).
VBH -	Barrel Velocity Head (ft) based on the average velocity determined by $V=Q/A_{full}$
VUH -	Upstream Velocity Head (ft) based on an inputted velocity.
EHU -	Upstream Energy Head (ft) available after bend losses and junction losses have been subtracted from VUH.
VCH -	Critical Depth Velocity Head (ft)
VNH -	Normal Depth Velocity Head (ft)
VEH -	Entrance Depth Velocity Head (ft)
VOH -	Outlet Depth Velocity Head (ft)

COEFFICIENTS / INLET DATA

KE -	Entrance Coefficient under Outlet Control
KB -	Bend Loss Coefficient
KJ -	Junction Loss Coefficient
K -	Inlet Control Equation parameter (See Table 4.3.1.A)
M -	Inlet Control Equation parameter (See Table 4.3.1.A)
C -	Inlet Control Equation parameter (See Table 4.3.1.A)
Y -	Inlet Control Equation parameter (See Table 4.3.1.A)
Q-Ratio -	Ratio of tributary flow to main upstream flow (Q_3/Q_1)

4.3.2 CULVERTS PROVIDING FOR FISH PASSAGE/MIGRATION

In fish-bearing waters, water-crossing **structures** must usually provide for fish passage as required for Washington State Department of Fish and Wildlife (WDFW) Hydraulic Project Approval or as a condition of permitting under the critical areas code (RMC 4-3-050). Culverts designed for fish passage must also meet the requirements of Section 1.2.4, “Core Requirement #4: Conveyance System.”

Fish passage can generally be ensured by providing **structures** that do not confine the streambed—that is, a **structure** wide enough so that the stream can maintain its natural channel within the culvert. Bridges, bottomless arch culverts, arch culverts, and rectangular box culverts (“utility vaults”) can often be used to accommodate stream channels.

Where it is unfeasible to construct these types of **structures**, round pipe culverts may be used if high flow velocities are minimized and low flow depths are maximized. The Hydraulic Code Rules (Title 220 WAC) detail requirements for WDFW Hydraulic Project Approval. See the WDFW manual “Design of Road Culverts for Fish Passage” for detailed design methodologies.

Materials

Galvanized metals leach zinc into the environment, especially in standing water situations. High zinc concentrations, sometimes in the range that can be toxic to aquatic life, have been observed in the region. Therefore, use of galvanized materials in stormwater facilities is not allowed, and their use in conveyance systems is discouraged. Where other metals, such as stainless steel, or plastics are available, they should be used.

4.3.2.1 DESIGN CRITERIA

Table 4.3.2.A lists allowable velocities, flow depths, and hydraulic drops for culverts in fish-bearing streams. Velocities are for the **high flow design discharge**; water depths are for the **low flow design discharge**. The *hydraulic drop* (a vertical drop in the water surface profile at any point within culvert influence) is for all flows between the high and low flow design discharges.

TABLE 4.3.2.A FISH PASSAGE DESIGN CRITERIA			
	Adult Trout	Adult Pink, Chum Salmon	Adult Chinook, Coho, Sockeye, Steelhead
1. Max Velocity (fps)			
Culvert Length:			
10–60 ft	4.0	5.0	6.0
60–100 ft	4.0	4.0	5.0
100–200 ft	3.0	3.0	4.0
2. Min Flow Depth (ft)	0.8	0.8	1.0
3. Max Hydraulic Drop (ft)	0.8	0.8	1.0

Source: WDFW manual “Design of Road Culverts for Fish Passage” (2003), Chapter 5, p. 21, Table 5-1.

4.3.2.2 METHODS OF ANALYSIS

High Flow Design Discharge

For **gaged streams**, the high flow design discharge shall be estimated by the 10% exceedance flow for October through April inclusive, proportioned by tributary area to the culvert using the technique described in Section 4.4.2.4 under “Flood Flows from Stream Gage Data.”

For **ungaged streams**, the high flow design discharge shall be estimated by one of the following:

- The 10% exceedance flow for October through April inclusive for the nearest hydrologically similar gaged stream, proportioned by tributary area
- The 5% exceedance flow determined through duration analysis with the approved model
- The 10% exceedance flow for October through April inclusive determined with the HSPF model or the approved model using the full historical record.

Low Flow Design Discharge

For **gaged streams**, the low flow design discharge shall be estimated by the 95% exceedance flow for October through April inclusive, proportioned by tributary area.

For **ungaged streams**, the low flow design discharge shall be estimated by one of the following:

- The 95% exceedance flow for October through April inclusive for the nearest hydrologically similar gaged stream, proportioned by tributary area
- The 95% exceedance flow for October through April inclusive, determined by the HSPF model or the approved model using the full historical record
- The following equation, using input data from the approved model (Note: Equation 4-9 is not used):

For the Sea-Tac rainfall region:

$$Q_l = f_r(0.46A_{tf} + 0.56A_{tp} + 0.46A_{tg} + 0.72A_{of} + 0.96A_{op} + 1.10A_{og}) / 1000 \quad (4-7)$$

where

- Q_l = low flow design discharge (cfs)
- f_r = regional rainfall scale factor from the WWHM2012 Site Information map screen
- A_{tf} = area of till forest (acres)
- A_{tp} = area of till pasture (acres)
- A_{tg} = area of till grass (acres)
- A_{of} = area of outwash forest (acres)
- A_{op} = area of outwash pasture (acres)
- A_{og} = area of outwash grass (acres)

Note: Minimum depths may also be met by providing an “installed no-flow depth,” per Title 220 WAC, where the static water surface level meets minimum flow depth criteria.

4.3.3 BRIDGES

Bridges over waterways are considered conveyance **structures** and are generally constructed to allow the continuation of a thoroughfare (such as a road). They generally consist of foundation abutments and/or piers that support a deck spanning the waterway. In addition to the **design criteria for conveyance** described below, bridge designs must meet the City of Renton Transportation requirements, AASHTO Standard Specifications for Highway Bridges or AASHTO LRFD Bridge Design Specifications and the most current WSDOT/APWA Standard Specifications as well as the requirements of other agencies such as the Washington State Department of Fish and Wildlife (WDFW).

4.3.3.1 DESIGN CRITERIA

Bridges shall be designed to convey flows and pass sediments and debris for runoff events up to and including the 100-year event in a manner that does not increase the potential for flooding or erosion to properties and **structures** near or adjacent to the bridge, or cause bridge failure. Inadequate conveyance capacity may cause flooding to increase by restricting flow through the hydraulic openings, by placing approach fill or abutments in floodplains, by causing changes in channel gradient and alignment or by trapping debris. A common mode of bridge failure involving debris is the resultant scour and undermining of piers or abutments where debris accumulates.

Openings between the structural elements of the bridge and the bottom of the channel or floodplain ground surface must be large enough to allow for passage of water, sediment, and debris. The horizontal openings are defined by the bridge span, the horizontal distances between piers or abutments.

Bridge clearance is the vertical distance between the 100-year water surface and the low chord of the bridge. For stream crossing locations where the 100-year peak flow exceeds 100 cfs, the height of a bridge clearance above rivers and streams shall be a minimum three feet above the 100-year water surface elevation unless otherwise required by the City based on evaluation of the design criteria in this section. For stream crossing locations where the 100-year peak flow is 100 cfs or less, there is no specific clearance requirement.

Hydraulic Capacity

Bridge and approach roads must **pass the 100-year flow** without creating hydraulic restrictions that cause or increase flooding. Design of bridge and approach roads shall demonstrate compliance with the compensatory storage provisions of RMC 4-3-050. Of necessity, bridge and approach roads are sometimes constructed within 100-year floodplains. In some cases, approach roads will be inundated and the bridge will not be accessible during extreme events. In other cases, both the bridge and approach roads will be inundated by the 100-year flood. In these cases, the bridge shall be designed to withstand the expected condition while inundated. The design shall employ means to facilitate flow over the bridge and to minimize the potential for erosion of the roadway fill in the approach roads.

Bed Aggradation

Where bed aggradation is probable, the analysis of hydraulic capacity shall assume the bed raised by an amount expected during a suitable **design life** (40 years minimum) of the bridge. Aggradation estimates shall be based on a sediment transport analysis that, where possible, is calibrated to direct cross-section comparisons over time. This analysis shall extend upstream and downstream a sufficient distance to adequately characterize bed aggradation that may affect the hydraulic capacity at the bridge location.

Bed aggradation is frequently associated with channel migration. The location and design of bridges and approach roads shall consider **channel migration hazards**.

Debris Passage

Since debris can pass through an opening either partly or totally submerged, the total vertical clearance from the bottom of the **structure** to the streambed needs to be considered. Required clearance for debris shall include an assessment of the maximum material size available, the ability of the stream to transport it, and the proximity of debris sources. The **following factors also must be considered**: history of debris problems in the river reaches upstream and downstream of the proposed bridge location, history of debris accumulations on an existing bridge **structure** or nearby **structures** upstream and downstream from the proposed bridge location, mapped channel migration hazard and channel migration history of the reach of stream, and skew of the bridge alignment such that piers in floodplain may be in the path of the debris. For a detailed qualitative analysis of debris accumulation on bridges, see the *U.S. Department of Transportation, Federal Highway Administration Publication FHWA-RD-97-028, Potential Drift Accumulation at Bridges*, by Timothy H. Diehl (1997).

Safety Margin

When designing bridges to convey flows and pass sediments and debris, a safety margin **shall be considered** by the design engineer to account for uncertainties in flow rates, debris hazards, water surface elevations, aggradation, and channel migration over time. The safety margin should be increased when the surrounding community is especially susceptible to flood damages that could be exacerbated by a debris jam at the bridge. Section 5 of the Technical Information Report submitted with the **project's** engineering plans shall include a discussion of the need for a safety margin and the rationale for its selection.

Bridges and Levees

Where bridge **structures** and approach roads intersect flood containment levees, the bridge **structure** and approach roads shall be designed and constructed to preserve existing levels of flood containment provided by the existing levee.

Where the existing levee currently provides containment of the 100-year flood, the bridge **structure** and approach roads shall be designed and constructed to meet FEMA levee and structural performance standards, including sufficient freeboard on the levee in the bridge vicinity, as provided for in 44 CFR (also see Section 1.3.3, Special Requirement #3, Flood Protection Facilities).

Bridge Piers and Abutments

Bridge pier and abutment locations are governed by provisions of the City's critical areas code, RMC 4-3-050.

4.3.3.2 METHODS OF ANALYSIS

The following methods are acceptable for hydraulic analysis of **bridges** and approach roads:

1. The **Direct Step backwater method** described in Section 4.4.1.2 shall be used to analyze the hydraulic impacts of bridge piers, abutments, and approach roads to the water surface profile.
2. The Army Corps of Engineers Hydraulic Engineering Center publishes **technical papers on methods** used to address the hydraulic effects of bridge piers, abutments, and approach roads. The book *Open Channel Hydraulics* by V.T. Chow also contains techniques for analyzing hydraulic effects.

(This page intentionally left blank.)

4.4 OPEN CHANNELS, FLOODPLAINS, AND FLOODWAYS

This section presents the methods, criteria, and details for hydraulic analysis and design of open channels, and the determination and analysis of floodplains and floodways. The information presented is organized as follows:

- Section 4.4.1, “Open Channels”
 - “Design Criteria,” Section 4.4.1.1
 - “Methods of Analysis,” Section 4.4.1.2
- Section 4.4.2, “Floodplain/Floodway Analysis”
 - “No Floodplain Study Required,” Section 4.4.2.1
 - “Approximate Floodplain Study,” Section 4.4.2.2
 - “Minor Floodplain Study,” Section 4.4.2.3
 - “Major Floodplain/Floodway Study,” Section 4.4.2.4.

4.4.1 OPEN CHANNELS

Open channels may be classified as either natural or constructed. Natural channels are generally referred to as rivers, streams, creeks, or swales, while constructed channels are most often called ditches, or simply channels. The Critical Areas, Shorelines, and Clearing and Grading Codes as well as Chapter 1 of this manual should be reviewed for requirements related to streams.

Natural Channels

Natural channels are defined as those that have occurred naturally due to the flow of surface waters, or those that, although originally constructed by human activity, have taken on the appearance of a natural channel including a stable route and biological community. They may vary hydraulically along each channel reach and should be left in their natural condition, wherever feasible or required, in order to maintain natural hydrologic functions and wildlife habitat benefits from established vegetation.

Constructed Channels

Constructed channels are those constructed or maintained by human activity and include bank stabilization of natural channels. Constructed channels shall be either vegetation-lined, rock-lined, or lined with appropriately bioengineered vegetation⁵.

- Vegetation-lined channels are the most desirable of the constructed channels when properly designed and constructed. The vegetation stabilizes the slopes of the channel, controls erosion of the channel surface, and removes pollutants. The channel storage, low velocities, water quality benefits, and greenbelt multiple-use benefits create significant advantages over other constructed channels. The presence of vegetation in channels creates turbulence that results in loss of energy and increased flow retardation; therefore, the design engineer must consider sediment deposition and scour, as well as flow capacity, when designing the channel.
- Rock-lined channels are necessary where a vegetative lining will not provide adequate protection from erosive velocities. They may be constructed with riprap, gabions, or slope mattress linings. The rock lining increases the turbulence, resulting in a loss of energy and increased flow retardation. Rock lining also permits a higher design velocity and therefore a steeper design slope than in grass-lined

⁵ *Bioengineered vegetation lining* as referenced here applies to channel stabilization methods. See Appendix C, *Simplified Drainage Requirements* for bioswale design criteria. Note, for bioswales and other infiltrative BMPs that may be placed in-line with conveyance, any infiltration option in the modeling shall be turned off when evaluating conveyance capacity.

channels. Rock linings are also used for erosion control at culvert and storm drain outlets, sharp channel bends, channel confluences, and locally steepened channel sections.

- Bioengineered vegetation lining is a desirable alternative to the conventional methods of rock armoring. Soil bioengineering is a highly specialized science that uses living plants and plant parts to stabilize eroded or damaged land. Properly bioengineered systems are capable of providing a measure of immediate soil protection and mechanical reinforcement. As the plants grow they produce a vegetative protective cover and a root reinforcing matrix in the soil mantle. This root reinforcement serves several purposes:
 - a) The developed anchor roots provide both shear and tensile strength to the soil, thereby providing protection from the frictional shear and tensile velocity components to the soil mantle during the time when flows are receding and pore pressure is high in the saturated bank.
 - b) The root mat provides a living filter in the soil mantle that allows for the natural release of water after the high flows have receded.
 - c) The combined root system exhibits active friction transfer along the length of the living roots. This consolidates soil particles in the bank and serves to protect the soil *structure* from collapsing and the stabilization measures from failing.

The vegetative cover of bioengineered systems provides immediate protection during high flows by laying flat against the bank and covering the soil like a blanket. It also reduces pore pressure in saturated banks through transpiration by acting as a natural “pump” to “pull” the water out of the banks after flows have receded.

The King County publication *Guidelines for Bank Stabilization Projects* primarily focuses on *projects* on larger rivers and streams, but the concepts it contains may be used in conjunction with other natural resource information for stabilization *projects* on smaller systems. The *WDFW Integrated Streambank Protection Guidelines* is another useful reference.

4.4.1.1 DESIGN CRITERIA

General

1. **Open channels** shall be designed to provide required conveyance capacity and bank stability while allowing for aesthetics, habitat preservation, and enhancement. Open channels shall be consistent with the *WDFW Integrated Streambank Protection Guidelines*.
2. An **access easement for maintenance** is required along all constructed channels located on private property. Required easement widths and building setback lines vary with channel top width as shown in Table 4.1.
3. **Channel cross-section geometry** shall be trapezoidal, triangular, parabolic, or segmental as shown in Figure 4.4.1.C through Figure 4.4.1.E. **Side slopes** shall be no steeper than 3:1 for vegetation-lined channels and 2:1 for rock-lined channels. *Note: Roadside ditches shall comply with the City of Renton Standard Details.*
4. To reduce the likelihood that pollutants will be discharged to groundwater when untreated runoff is conveyed in ditches or channels constructed in soils with high infiltration rates, a **low permeability liner** or a **treatment liner** shall be provided for any reach of new ditch or channel proposed by a *project* in which the untreated runoff from 5,000 square feet or more of **pollution-generating impervious surface** comes into direct contact with an outwash soil, except where it can be demonstrated that the soil meets the soil suitability criteria listed in Section 5.2.1. The low permeability liner or treatment liner shall be consistent with the specifications for such liners in Section 6.2.4.
5. **Vegetation-lined channels** shall have **bottom slope gradients** of 6% or less and a **maximum velocity** at design flow of 5 fps (see Table 4.4.1.A).

6. **Rock-lined channels or bank stabilization of natural channels** shall be used when design flow velocities exceed 5 feet per second. Rock stabilization shall be in accordance with Table 4.4.1.A or stabilized with bioengineering methods as described above in “Constructed Channels.”

TABLE 4.4.1.A CHANNEL PROTECTION				
Velocity at Design Flow (fps)		Required Protection		
Greater than	Less than or Equal to	Type of Protection	Thickness	Minimum Height Above Design Water Surface
0	5	Grass lining or Bioengineered lining	N/A	N/A
5	8	Rock lining ⁽¹⁾ or Bioengineered lining	1 foot	1 foot
8	12	Riprap ⁽²⁾	2 feet	2 feet
12	20	Slope mattress gabion, etc.	Varies	2 feet

(1) Rock Lining shall be reasonably well graded as follows:
Maximum stone size: 12 inches
Median stone size: 8 inches
Minimum stone size: 2 inches

(2) Riprap shall be reasonably well graded as follows:
Maximum stone size: 24 inches
Median stone size: 16 inches
Minimum stone size: 4 inches

Note: Riprap sizing is governed by side slopes on channel, assumed to be approximately 3:1.

Riprap Design⁶

When riprap is set, stones are placed on the channel sides and bottom to protect the underlying material from being eroded. Proper riprap design requires the determination of the median size of stone, the thickness of the riprap layer, the gradation of stone sizes, and the selection of angular stones that will interlock when placed. Research by the U.S. Army Corps of Engineers has provided criteria for selecting the **median stone weight**, W_{50} (Figure 4.4.1.A). If the riprap is to be used in a highly turbulent zone (such as at a culvert outfall, downstream of a stilling basin, at sharp changes in channel geometry, etc.), the median stone W_{50} should be increased from 200% to 600% depending on the severity of the locally high turbulence. The thickness of the riprap layer should generally be twice the **median stone diameter** (D_{50}) or at least that of the maximum stone. The riprap should have a reasonably well graded assortment of stone sizes within the following gradation:

$$1.25 \leq D_{max}/D_{50} \leq 1.50$$

$$D_{15}/D_{50} = 0.50$$

$$D_{min}/D_{50} = 0.25$$

Detailed design methodology may be found in the Corps publication EM 1110-02-1601, Engineering and Design – Hydraulic Design of Flood Control Channels. For a more detailed analysis and design procedure for riprap requiring water surface profiles and estimates of tractive force, refer to the paper by Maynard et al. in *Journal of Hydraulic Engineering (A.S.C.E.)*, July 1989.

Riprap Filter Design

Riprap should be underlain by a sand and gravel filter (or filter fabric) to keep the fine materials in the underlying channel bed from being washed through the voids in the riprap. Likewise, the filter material must be selected so that it is not washed through the voids in the riprap. Adequate filters can usually be provided by a reasonably well graded sand and gravel material where:

$$D_{15} < 5d_{85}$$

The variable d_{85} refers to the sieve opening through which 85% of the material being protected will pass, and D_{15} has the same interpretation for the filter material. A filter material with a D_{50} of 0.5 mm will protect any finer material including clay. Where very large riprap is used, it is sometimes necessary to use two filter layers between the material being protected and the riprap.

Example:

What embedded riprap design should be used to protect a streambank at a level culvert outfall where the outfall velocities in the vicinity of the downstream toe are expected to be about 8 fps?

From Figure 4.4.1.A, $W_{50} = 6.5$ lbs, but since the downstream area below the outfall will be subjected to severe turbulence, increase W_{50} by 400% so that:

$$W_{50} = 26 \text{ lbs}, D_{50} = 8.0 \text{ inches}$$

The gradation of the riprap is shown in Figure 4.4.1.B, and the minimum thickness would be 1 foot (from Table 4.4.1.A); however, 16 inches to 24 inches of riprap thickness would provide some additional insurance that the riprap will function properly in this highly turbulent area.

Figure 4.4.1.B shows that the gradation curve for ASTM C33, size number 57 coarse aggregate (used in concrete mixes), would meet the filter criteria. Applying the filter criteria to the coarse aggregate demonstrates that any underlying material whose gradation was coarser than that of a concrete sand would be protected.

⁶ From a paper prepared by M. Schaefer, Dam Safety Section, Washington State Department of Ecology.

FIGURE 4.4.1.A
MEAN CHANNEL VELOCITY VS. MEDIUM STONE WEIGHT (W_{50}) AND EQUIVALENT STONE DIAMETER

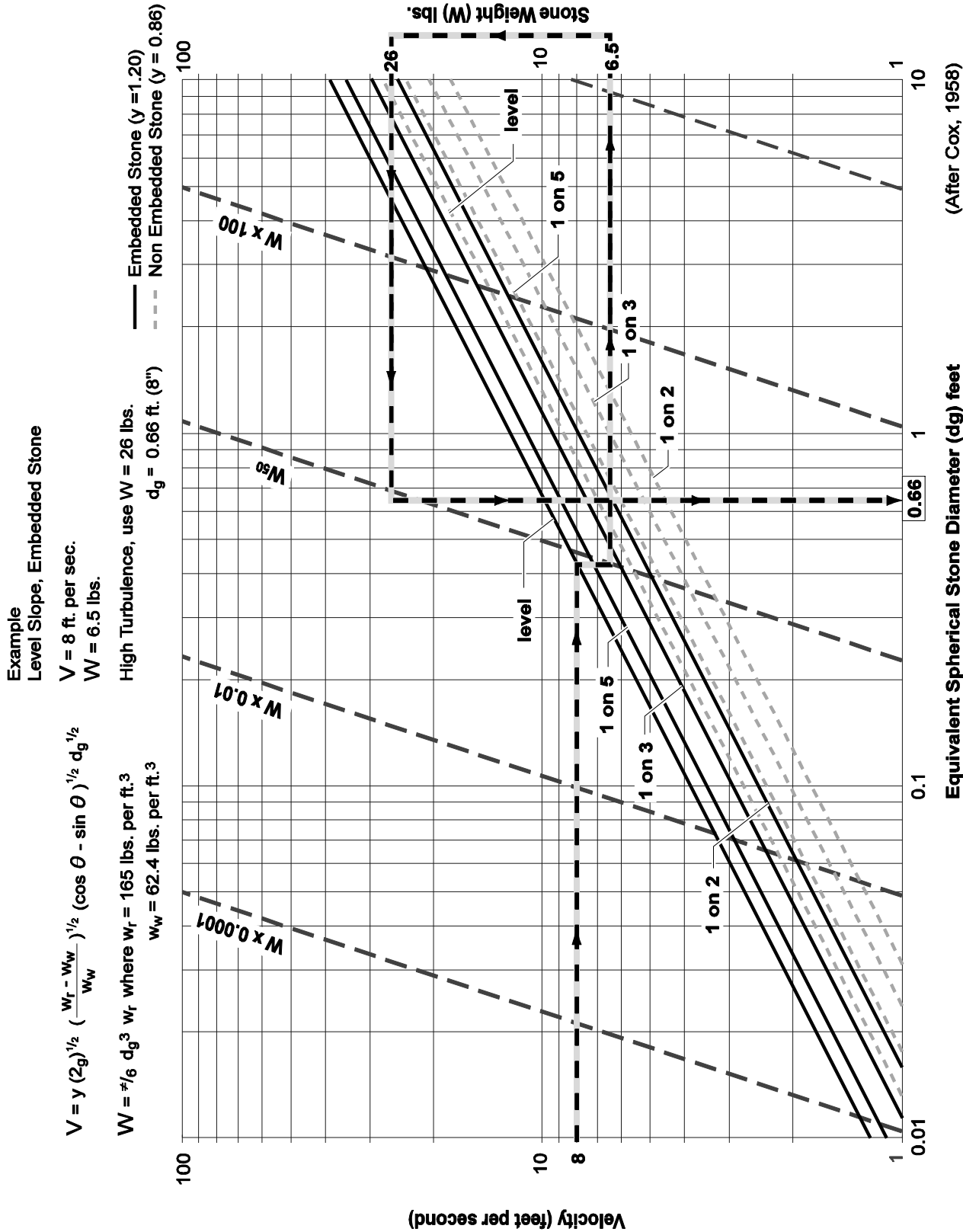
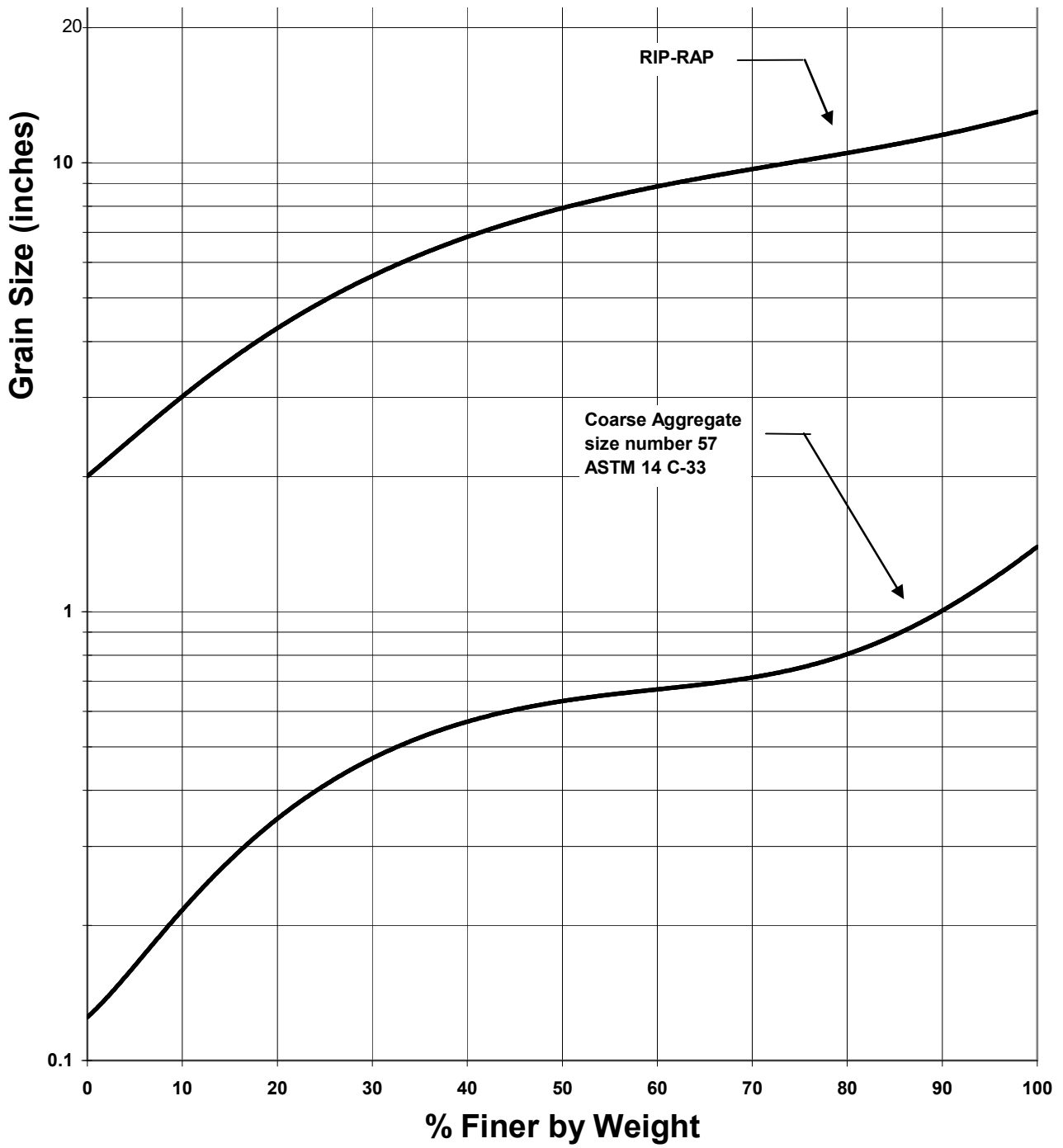

FIGURE 4.4.1.B RIPRAP/FILTER EXAMPLE GRADATION CURVE



4.4.1.2 METHODS OF ANALYSIS

This section presents the methods of analysis **for designing new or evaluating existing open channels** for compliance with the conveyance capacity requirements set forth in Section 1.2.4, “Core Requirement #4: Conveyance System.”

❑ DESIGN FLOWS

Design flows for sizing and assessing the capacity of open channels shall be determined using the hydrologic analysis methods described in Chapter 3.

❑ CONVEYANCE CAPACITY

There are three acceptable methods of analysis for sizing and analyzing the capacity of open channels:

1. Manning's equation for preliminary sizing
2. Direct Step backwater method
3. Standard Step backwater method.

Manning's Equation for Preliminary Sizing

Manning's equation is used for preliminary sizing of open channel reaches of uniform cross section and slope (i.e., prismatic channels) and uniform roughness. This method assumes the flow depth (or normal depth) and flow velocity remain constant throughout the channel reach for a given flow.

The charts in Figure 4.4.1.C and Figure 4.4.1.D may be used to obtain graphic solutions of Manning's equation for common ditch sections. For conditions outside the range of these charts or for more precise results, Manning's equation can be solved directly from its classic forms shown in Equations (4-1) and (4-2).

Table 4.4.1.B provides a reference for selecting the appropriate “*n*” values for open channels. A number of engineering reference books, such as *Open-Channel Hydraulics* by V.T. Chow, may also be used as guides to select “*n*” values. Figure 4.4.1.E contains the geometric elements of common channel sections useful in determining area *A*, wetted perimeter *WP*, and hydraulic radius ($R = A/WP$).

If flow restrictions occur that raise the water level above normal depth within a given channel reach, a *backwater condition* (or subcritical flow) is said to exist. This condition can result from flow restrictions created by a downstream culvert, bridge, dam, pond, lake, etc., and even a downstream channel reach having a higher flow depth. If backwater conditions are found to exist for the design flow, a backwater profile must be computed to verify that the channel's capacity is still adequate as designed. The Direct Step or Standard Step backwater methods presented in this section may be used for this purpose.

TABLE 4.4.1.B VALUES OF ROUGHNESS COEFFICIENT “n” FOR OPEN CHANNELS			
Type of Channel and Description	Manning's “n”* (normal)	Type of Channel and Description	Manning's “n”* (normal)
A. Constructed Channels			
a. Earth, straight and uniform		6. Sluggish reaches, weedy deep pools	0.070
1. Clean, recently completed	0.018	7. Very weedy reaches, deep pools, or floodways with heavy stand of timber and underbrush	0.100
2. Gravel, uniform section, clean	0.025		
3. With short grass, few weeds	0.027	b. Mountain streams, no vegetation in channel, banks usually steep, trees and brush along banks submerged at high stages	
b. Earth, winding and sluggish	0.025	1. Bottom: gravel, cobbles, and few boulders	0.040
1. No vegetation	0.030	2. Bottom: cobbles with large boulders	0.050
2. Grass, some weeds	0.035	B-2 Floodplains	
3. Dense weeds or aquatic plants in deep channels	0.030	a. Pasture, no brush	
4. Earth bottom and rubble sides	0.035	1. Short grass	
5. Stony bottom and weedy banks	0.040	2. High grass	0.030
6. Cobble bottom and clean sides	0.040	b. Cultivated areas	0.035
c. Rock lined		1. No crop	0.030
1. Smooth and uniform	0.035	2. Mature row crops	0.030
2. Jagged and irregular	0.040	3. Mature field crops	0.035
d. Channels not maintained, weeds and brush uncut		c. Brush	0.040
1. Dense weeds, high as flow depth	0.080	1. Scattered brush, heavy weeds	0.050
2. Clean bottom, brush on sides	0.050	2. Light brush and trees	0.060
3. Same as #2, highest stage of flow	0.070	3. Medium to dense brush	0.070
4. Dense brush, high stage	0.100	4. Heavy, dense brush	0.100
B. Natural Streams			
B-1 Minor streams (top width at flood stage < 100 ft.)		d. Trees	
a. Streams on plain		1. Dense willows, straight	0.150
1. Clean, straight, full stage no rifts or deep pools	0.030	2. Cleared land with tree stumps, no sprouts	0.040
2. Same as #1, but more stones and weeds	0.035	3. Same as #2, but with heavy growth of sprouts	0.060
3. Clean, winding, some pools and shoals	0.040	4. Heavy stand of timber, a few down trees, little undergrowth, flood stage below branches	0.100
4. Same as #3, but some weeds	0.040	5. Same as #4, but with flood stage reaching branches	0.120
5. Same as #4, but more stones	0.050		
* Note: These “n” values are “normal” values for use in analysis of channels. For conservative design of channel capacity, the maximum values listed in other references should be considered. For channel bank stability, the minimum values should be considered.			

Direct Step Backwater Method

The Direct Step backwater method may be used to compute backwater profiles on prismatic channel reaches (i.e., reaches having uniform cross section and slope) where a backwater condition or restriction to normal flow is known to exist. The method may be applied to a series of prismatic channel reaches in succession beginning at the downstream end of the channel and computing the profile upstream.

Calculating the coordinates of the water surface profile using this method is an iterative process achieved by choosing a range of flow depths, beginning at the downstream end, and proceeding incrementally up to the point of interest or to the point of normal flow depth. This is best accomplished by the use of a table (see Figure 4.4.1.G) or computer programs (as discussed in "Computer Applications" in Section 4.4.1.2).

To illustrate analysis of a single reach, consider the following diagram:

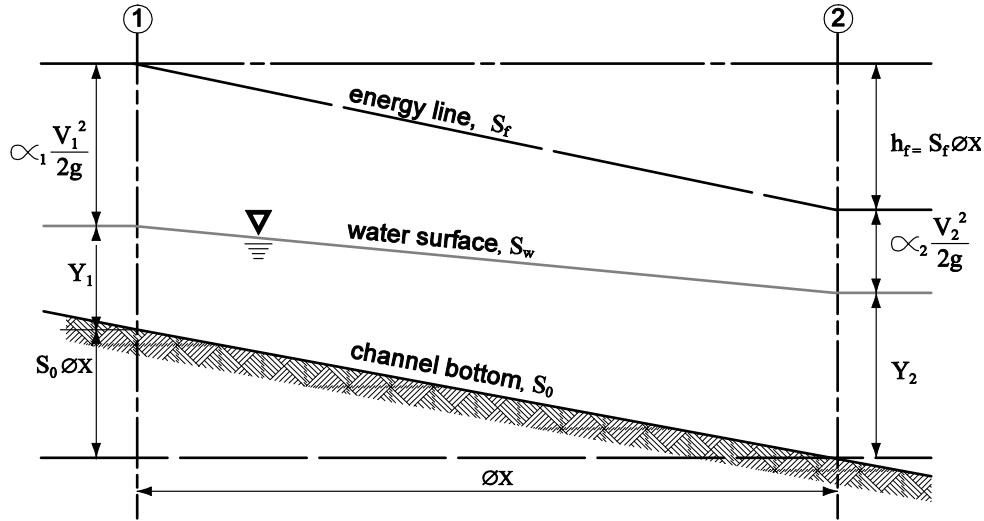

Equating the total head at cross sections 1 and 2, the following equation may be written:

$$S_o \Delta x + y_1 + \alpha_1 \frac{V_1^2}{2g} = y_2 + \alpha_2 \frac{V_2^2}{2g} + S_f \Delta x \quad (4-8)$$

where,

- Δx = distance between cross sections (ft)
- y_1, y_2 = depth of flow (ft) at cross sections 1 and 2
- V_1, V_2 = velocity (fps) at cross sections 1 and 2
- α_1, α_2 = energy coefficient at cross sections 1 and 2
- S_o = bottom slope (ft/ft)
- S_f = friction slope = $(n^2 V^2) / (2.21 R^{1.33})$
- g = acceleration due to gravity, (32.2 ft/sec²)

If the specific energy E at any one cross-section is defined as follows:

$$E = y + \alpha \frac{V^2}{2g} \quad (4-9)$$

and assuming $\alpha = \alpha_1 = \alpha_2$ where α is the energy coefficient that corrects for the non-uniform distribution of velocity over the channel cross section, Equations 4-10 and 4-11 can be combined and rearranged to solve for Δx as follows:

$$\Delta x = (E_2 - E_1)/(S_o - S_f) = \Delta E/(S_o - S_f) \quad (4-10)$$

Typical values of the energy coefficient α are as follows:

Channels, regular section	1.15
Natural streams	1.3
Shallow vegetated flood fringes (includes channel)	1.75

For a given flow, channel slope, Manning's "n," and energy coefficient α , together with a beginning water surface elevation y_2 , the values of Δx may be calculated for arbitrarily chosen values of y_1 . The coordinates defining the water surface profile are obtained from the cumulative sum of Δx and corresponding values of y .

The **normal flow depth**, y_n , should first be calculated from Manning's equation to establish the upper limit of the backwater effect.

Standard Step Backwater Method

The Standard Step Backwater Method is a variation of the Direct Step Backwater Method and may be used to compute backwater profiles on both prismatic and non-prismatic channels. In this method, stations are established along the channel where cross section data is known or has been determined through field survey. The computation is carried out in steps from station to station rather than throughout a given channel reach as is done in the Direct Step method. As a result, the analysis involves significantly more trial-and-error calculation in order to determine the flow depth at each station.

Computer Applications

Because of the iterative calculations involved, use of a computer to perform the analysis is recommended. The **King County Backwater (KCBW) computer program** included in the software package available with this manual includes a subroutine, **BWCHAN**, based on the Standard Step backwater method, which may be used for all channel capacity analysis. It can also be combined with the **BWPIPE** and **BWCULV** subroutines to analyze an entire drainage conveyance system. A schematic description of the nomenclature used in the **BWCHAN** subroutine is provided in Figure 4.4.1.H. See the KCBW program documentation for further information.

There are a number of commercial software programs for use on personal computers that use variations of the Standard Step backwater method for determining water surface profiles. The most common and widely accepted program is called HEC-RAS, published and supported by the United States Army Corps of Engineers Hydraulic Engineering Center. It is one of the models accepted by FEMA for use in performing flood hazard studies for preparing flood insurance maps.

FIGURE 4.4.1.C DITCHES — COMMON SECTIONS

PROPERTIES OF DITCHES

NO.	DIMENSIONS				HYDRAULICS			
	Side Slopes	B	H	W	A	WP	R	R ^(2/3)
D-1	–	–	6.5"	5'-0"	1.84	5.16	0.356	0.502
D-1C	–	–	6"	25'-0"	6.25	25.50	0.245	0.392
D-2A	1.5:1	2'-0"	1'-0"	5'-0"	3.50	5.61	0.624	0.731
B	2:1	2'-0"	1'-0"	6'-0"	4.00	6.47	0.618	0.726
C	3:1	2'-0"	1'-0"	8'-0"	5.00	8.32	0.601	0.712
D-3A	1.5:1	3'-0"	1'-6"	7'-6"	7.88	8.41	0.937	0.957
B	2:1	3'-0"	1'-6"	9'-0"	9.00	9.71	0.927	0.951
C	3:1	3'-0"	1'-6"	12'-0"	11.25	12.49	0.901	0.933
D-4A	1.5:1	3'-0"	2'-0"	9'-0"	12.00	10.21	1.175	1.114
B	2:1	3'-0"	2'-0"	11'-0"	14.00	11.94	1.172	1.112
C	3:1	3'-0"	2'-0"	15'-0"	18.00	15.65	1.150	1.098
D-5A	1.5:1	4'-0"	3'-0"	13'-0"	25.50	13.82	1.846	1.505
B	2:1	4'-0"	3'-0"	16'-0"	30.00	16.42	1.827	1.495
C	3:1	4'-0"	3'-0"	22'-0"	39.00	21.97	1.775	1.466
D-6A	2:1	–	1'-0"	4'-0"	2.00	4.47	0.447	0.585
B	3:1	–	1'-0"	6'-0"	3.00	6.32	0.474	0.608
D-7A	2:1	–	2'-0"	8'-0"	8.00	8.94	0.894	0.928
B	3:1	–	2'-0"	12'-0"	12.00	12.65	0.949	0.965
D-8A	2:1	–	3'-0"	12'-0"	18.00	13.42	1.342	1.216
B	3:1	–	3'-0"	18'-0"	27.00	18.97	1.423	1.265
D-9	7:1	–	1'-0"	14'-0"	7.00	14.14	0.495	0.626
D-10	7:1	–	2'-0"	28'-0"	28.00	28.28	0.990	0.993
D-11	7:1	–	3'-0"	42'-0"	63.00	42.43	1.485	1.302

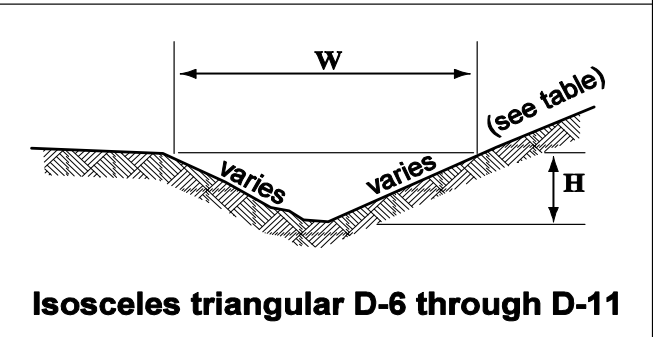
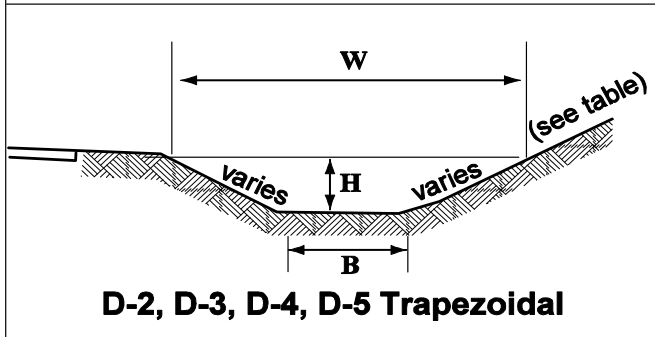
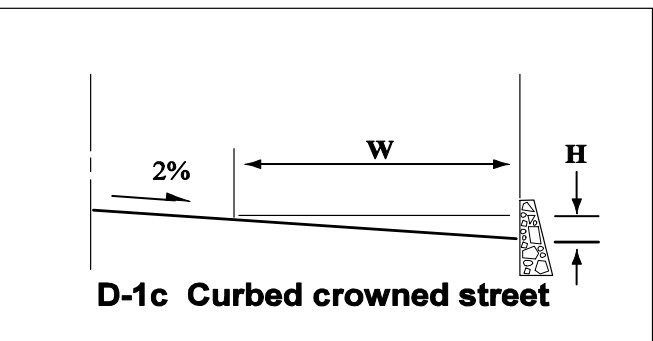
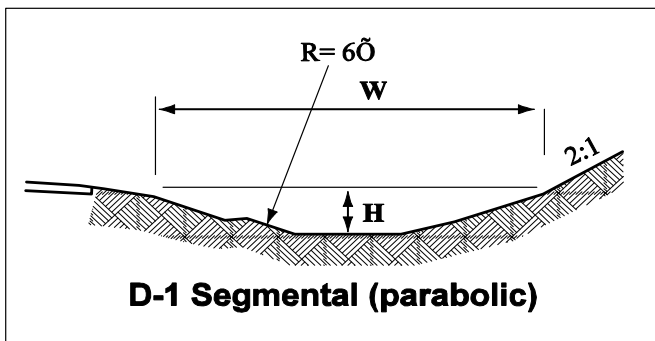

FIGURE 4.4.1.D DRAINAGE DITCHES — COMMON SECTIONS

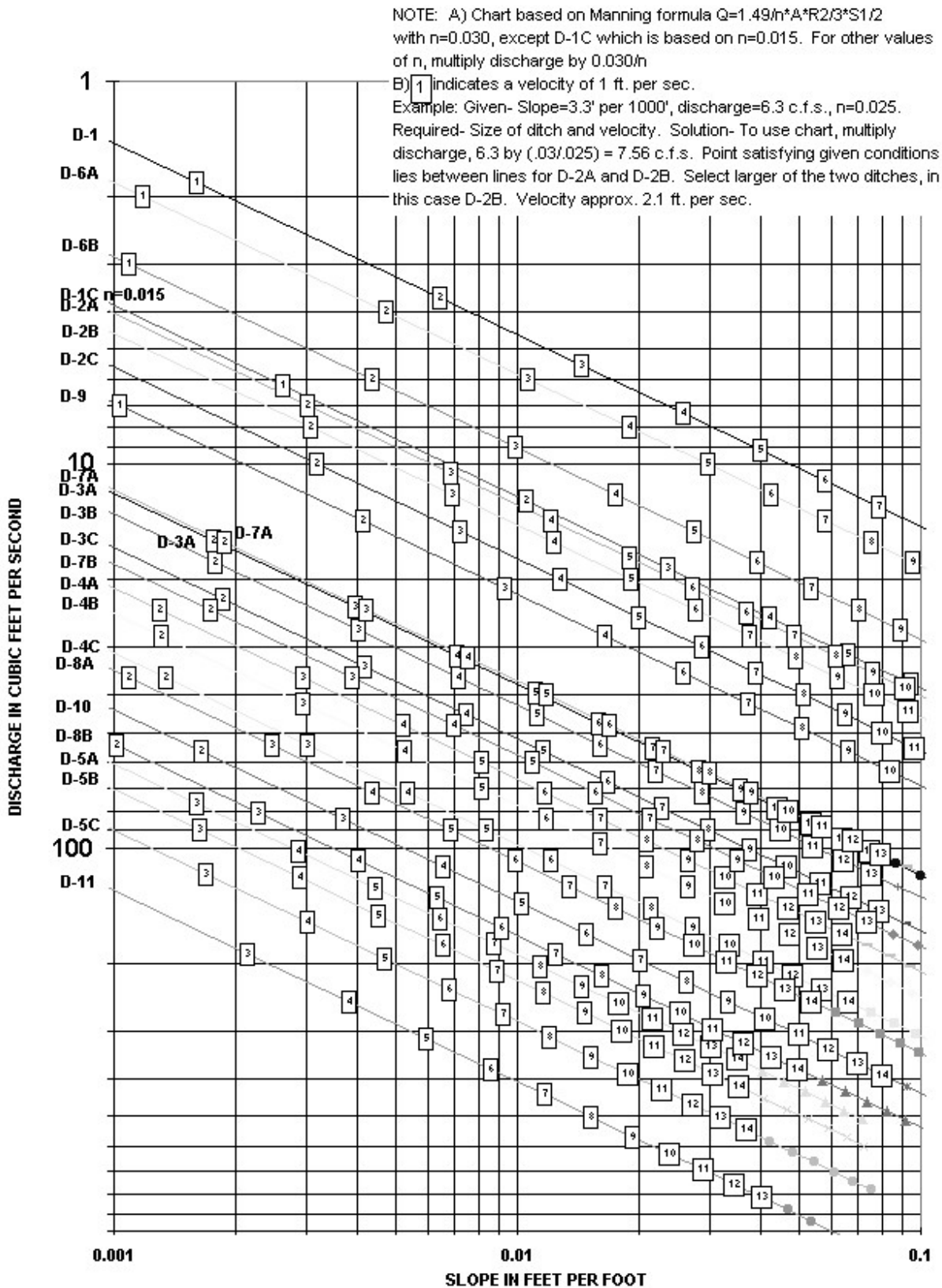
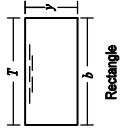
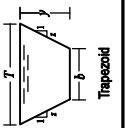
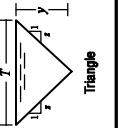
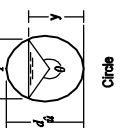
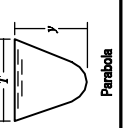
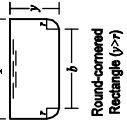
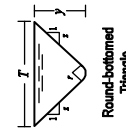

FIGURE 4.4.1.E GEOMETRIC ELEMENTS OF COMMON SECTIONS

Section	Area A	Wetted perimeter P	Hydraulic radius R	Top width W	Hydraulic depth D	Section factor Z
 Rectangle	by	$b + 2y$	$\frac{by}{b + 2y}$	b	y	$by^{1.5}$
 Trapezoid	$(b + zy)y$	$b + 2y\sqrt{1 + z^2}$	$\frac{(b + zy)y}{b + 2y\sqrt{1 + z^2}}$	$b + 2zy$	$\frac{(b + zy)y}{b + 2zy}$	$\frac{[(b + zy)y]^{1.5}}{\sqrt{b + 2zy}}$
 Triangle	zy^2	$2y\sqrt{1 + z^2}$	$\frac{zy}{2\sqrt{1 + z^2}}$	$2zy$	$1/2y$	$\frac{\sqrt{2}}{2}zy^{2.5}$
 Circle	$1/8(\theta \text{ D sin}\theta)^2 \hat{u}$	$1/2\theta d \hat{u}$	$1/4(1 \text{ D sin}\theta / \theta) d \hat{u}$	$(\text{sin}(1/2\theta) d) \hat{u}$ or $2\sqrt{y} (d \text{ D } y)$	$1/8 \left(\frac{\theta \text{ D sin}\theta}{\text{sin}(1/2\theta)} \right) d \hat{u}$	$\frac{\sqrt{2} (\theta \text{ D sin}\theta)^{1.5}}{32 (\text{sin}(1/2\theta))^{0.5}} d^{2.5} \hat{u}$
 Parabola	$2/3 Ty$	$T + \frac{8y^2}{3T}$	$\frac{2T^2y}{3T^2 + 8y^2}$ *	$\frac{3A}{2y}$	$2/3y$	$2/9\sqrt{6Ty}^{1.5}$
 Round-cornered Rectangle ($y > r$)	$(\frac{\pi}{2} \text{ D } 2)r^2 + (b + 2r)y$	$(\neq \text{ D } 2)r + b + 2y$	$\frac{(\frac{\pi}{2} \text{ D } 2)r^2 + (b + 2r)y}{(\neq \text{ D } 2)r + b + 2y}$	$b + 2r$	$\frac{(\frac{\pi}{2} \text{ D } 2)r^2}{(b + 2r)} + y$	$\frac{[(\frac{\pi}{2} \text{ D } 2)r^2 + (b + 2r)y]^{1.5}}{\sqrt{b + 2y}}$
 Round-bottomed Triangle	$\frac{T^2}{4z} - \frac{r^2}{z} (1 \text{ D } z \text{ cof}^1 z)$	$\frac{T}{z} \sqrt{1 + z^2} - \frac{2r}{z} (1 \text{ D } z \text{ cof}^1 z)$	$\frac{A}{P}$	$2[z(y \text{ D } r) + \pi \sqrt{1 + z^2}]$	$\frac{A}{T}$	$A \sqrt{\frac{A}{T}}$

*Satisfactory approximation for the interval $0 < x < 1$, where $x = 4y/T$. When $x > 1$, use the exact expression $P = (\frac{1}{2}) [\sqrt{1 + x^2} + 1/x \ln(x + \sqrt{1 + x^2})]$

FIGURE 4.4.1.F OPEN CHANNEL FLOW PROFILE COMPUTATION

$Q =$ _____		$n =$ _____		$S_o =$ _____		$\alpha =$ _____		$Y_n =$ _____				
y	A	R	R ^{4/3}	V	αV ² /2g	E	ΔE	S _f	— S _f	— S _o - S _f	Δx	x
(1)	(2)	(3)	(4)	(5)	(6)	(7)	(8)	(9)	(10)	(11)	(12)	(13)

FIGURE 4.4.1.G DIRECT STEP BACKWATER METHOD – EXAMPLE

y	A	R	$R^{4/3}$	V	$\alpha V^2/2g$	E	ΔE	S_f	\bar{S}_f	$S_o - S_f$	Δx	x
(1)	(2)	(3)	(4)	(5)	(6)	(7)	(8)	(9)	(10)	(11)	(12)	(13)
6.0	72.0	2.68	3.72	0.42	0.0031	6.0031	-	0.00002	-	-	-	-
5.5	60.5	2.46	3.31	0.50	0.0040	5.5040	0.4990	0.00003	0.000025	0.00698	71.50	71.5
5.0	50.0	2.24	2.92	0.60	0.0064	5.0064	0.4976	0.00005	0.000040	0.00696	71.49	142.99
4.5	40.5	2.01	2.54	0.74	0.0098	4.5098	0.4966	0.00009	0.000070	0.00693	71.64	214.63
4.0	32.0	1.79	2.17	0.94	0.0157	4.0157	0.4941	0.00016	0.000127	0.00687	71.89	286.52
3.5	24.5	1.57	1.82	1.22	0.0268	3.5268	0.4889	0.00033	0.000246	0.00675	72.38	358.90
3.0	18.0	1.34	1.48	1.67	0.0496	3.0496	0.4772	0.00076	0.000547	0.00645	73.95	432.85
2.5	12.5	1.12	1.16	2.40	0.1029	2.6029	0.4467	0.00201	0.001387	0.00561	79.58	512.43
2.0	8.0	0.89	0.86	3.75	0.2511	2.2511	0.3518	0.00663	0.004320	0.00268	131.27	643.70

The step computations are carried out as shown in the above table. The values in each column of the table are explained as follows:

- Col. 1. Depth of flow (ft) assigned from 6 to 2 feet
- Col. 2. Water area (ft²) corresponding to depth y in Col. 1
- Col. 3. Hydraulic radius (ft) corresponding to y in Col. 1
- Col. 4. Four-thirds power of the hydraulic radius
- Col. 5. Mean velocity (fps) obtained by dividing Q (30 cfs) by the water area in Col. 2
- Col. 6. Velocity head (ft)
- Col. 7. Specific energy (ft) obtained by adding the velocity head in Col. 6 to depth of flow in Col. 1
- Col. 8. Change of specific energy (ft) equal to the difference between the E value in Col. 7 and that of the previous step.
- Col. 9. Friction slope S_f , computed from V as given in Col. 5 and $R^{4/3}$ in Col. 4
- Col. 10. Average friction slope between the steps, equal to the arithmetic mean of the friction slope just computed in Col. 9 and that of the previous step
- Col. 11. Difference between the bottom slope, S_o , and the average friction slope, S_f
- Col. 12. Length of the reach (ft) between the consecutive steps;
Computed by $\Delta x = \Delta E / (S_o - S_f)$ or by dividing the value in Col. 8 by the value in Col. 11
- Col. 13. Distance from the beginning point to the section under consideration. This is equal to the cumulative sum of the values in Col. 12 computed for previous steps.

FIGURE 4.4.1.H BWCHAN COMPUTER SUBROUTINE – VARIABLE DEFINITIONS

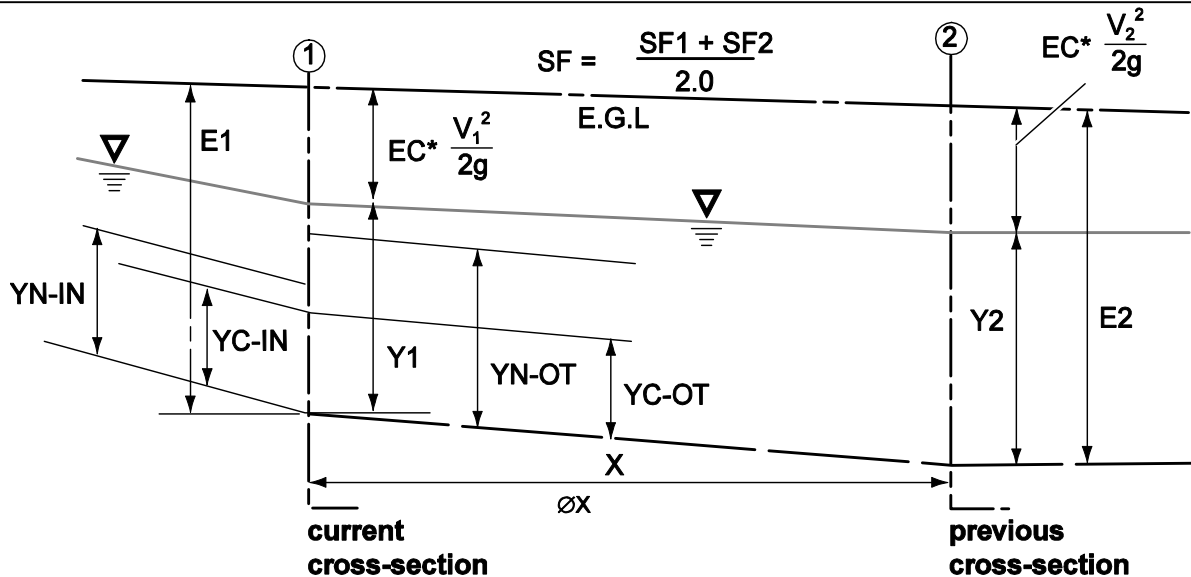

BWCHAN – VARIABLE DEFINITIONS	
YC-IN	Critical Depth (ft) at current section based on <i>incoming</i> flow rate.
YC-OT	Critical Depth (ft) at current section based on <i>outgoing</i> flow rate.
YN-IN	Normal Depth (ft) at current section based on <i>incoming</i> flow rate/channel grade.
YN-OT	Normal Depth (ft) at current section based on <i>outgoing</i> flow rate/channel grade.
Y1	Final Water Depth (ft) at current cross section
N-Y1	Composite n-factor of current section for final depth, Y1.
A-Y1	Cross-sectional Area of current section for final depth, Y1.
WP-Y1	Wetted Perimeter (ft) of current section for final depth, Y1.
V-Y1	Average Velocity (fps) of current section for final depth, Y1.
E1	Total Energy Head (ft) at current section $(Y1 + EC * V_1^2 / 2g)$
E2	Total Energy Head (ft) at pervious or downstream section.
SF1	Friction Slope of current section.
SF2	Friction Slope of previous or downstream section.
DX	Distance (expressed as a fraction of the current reach length) from the previous or downstream section to where the flow profile would intersect the final water depth, Y1, assuming Y1 were to remain constant
EC	Energy Coefficient "α"
Q-TW	The flow rate used to determine Tailwater Height from an inputted HW/TW Data File.
TW-HT	Tailwater Height.
Q-Y1	Flow rate (cfs) in channel at current section, for depth, Y1
VU-Y1	Upstream Velocity (fps) at current section for depth, Y1 ("Adjust" option).
V1-HD	Channel Velocity Head (ft) at current section.
VU-HD	Upstream Velocity Head (ft) at current section.

4.4.2 FLOODPLAIN/FLOODWAY ANALYSIS

This section describes the floodplain/floodway studies required by Special Requirement #2, **Flood Hazard Area** Delineation, in Section 1.3.2. Floodplain/floodway studies, as required by this manual, establish base flood elevations and delineate floodplains and/or floodways when the City determines that a proposed **project** contains or is adjacent to a **flood hazard area** for a river, stream, lake, wetland, closed depression, marine shoreline, or other water feature. Furthermore, when **development** is proposed within the floodplain, the floodplain/floodway study is used to show compliance with the critical areas code (RMC 4-3-050) **flood hazard area** regulations.

There are four conditions affecting the requirements for floodplain/floodway studies. Each condition is considered a threshold for determining the type of studies required and the documentation needed to meet the study requirements. Each study threshold and related study requirements are shown in the table below, and described further in this section.

Note that any **projects** or related flood studies that are expected to result in a change to Base Flood Elevations published in FEMA Flood Insurance Studies and Rate Maps, must also comply with 44 CFR Part 65.

TABLE 4.4.2.A FLOODPLAIN/FLOODWAY STUDY THRESHOLDS AND REQUIREMENTS		
Threshold	Study	Requirements
The project site is on land that is outside of an already delineated floodplain and above the floodplain's base flood elevation based on best available floodplain data.	No floodplain study required	<ul style="list-style-type: none"> Show delineation of floodplain on the site improvement plan and indicate base flood elevation Record a notice on title See Section 4.4.2.1 for more details
The project site is on land that is at least 10 feet above the ordinary high water mark or 2 feet above the downstream overflow elevation of a water feature for which a floodplain has not been determined.	Approximate Floodplain Study per Section 4.4.2.2	<ul style="list-style-type: none"> Submit an engineering plan with approximate base flood elevation Record a notice on title See Section 4.4.2.2 for more details
The project site does not meet the above thresholds and is either on land that is outside of an already delineated Zone A floodplain (i.e., without base flood elevations determined), or is adjacent to a water feature for which a floodplain has not been determined.	Minor Floodplain Study per Section 4.4.2.3	<ul style="list-style-type: none"> Backwater model Submit an engineering plan with determined base flood elevation¹ Record a notice on title See Section 4.4.2.3 for more details
The project site is on land that is partially or fully within an already delineated floodplain of a river or stream, or is determined by a Minor Floodplain Study to be partially or fully within the floodplain of a river or stream.	Major Floodplain/Floodway Study per Section 4.4.2.4	<ul style="list-style-type: none"> Show mapped floodplain/floodway on the site improvement plan and indicate base flood elevation Record a notice on title See further requirements in Section 4.4.2.4
For any project site or study that is intended to result in a change to FEMA Flood Insurance Study or Rate Maps, including changing published based flood elevations, the applicant must comply with documentation and approval requirements of FEMA regulations 44 CFR Part 65.		
¹ For marine shorelines, refer to the FEMA <i>Guidelines and Specifications for Flood Hazard Mapping Partners</i> .		

4.4.2.1 NO FLOODPLAIN STUDY REQUIRED

IF the proposed *project site* is on land that is outside of an already delineated floodplain and is above the already determined base flood elevation for that floodplain, based on best available floodplain data, THEN no floodplain study is required.

In this situation, if the already determined floodplain covers any portion of the *site*, the boundary of that floodplain and its base flood elevation must be shown on the *project's* site improvement plan. In addition, a **notice on title** must be recorded for the *site*, alerting future property owners of the presence of a **flood hazard area** on the *site* and its base flood elevation. The notice on title requirement may be waived if the floodplain is not on any portion of the *site*.

4.4.2.2 APPROXIMATE FLOODPLAIN STUDY

If the proposed *project site* is on land that is at least 10 feet above the ordinary high water mark or 2 feet above the downstream overflow elevation of a water feature for which the floodplain has not been delineated, then an Approximate Floodplain Study may be used to determine an approximate floodplain and base flood elevation.

The **intent** of the Approximate Floodplain Study is to reduce required analysis in those situations where the *project site* is adjacent to a **flood hazard area**, but by virtue of significant topographical relief, is clearly in no danger of flooding. The minimum 10 feet of separation from ordinary high water reduces the level of required analysis for those *projects* adjacent to streams confined to deep channels or ravines, or near lakes or wetlands. The minimum 2 feet clearance above the downstream overflow elevation is intended to avoid **flood hazard areas** created by a downstream impoundment of water behind a road fill or in a lake, wetland, or closed depression.

Use of the Approximate Floodplain Study requires submittal of an *engineering plan*⁷ showing the proposed *project site* is at least 10 feet above the ordinary high water elevation of the water feature in question, or at least 2 feet above the downstream overflow elevation of the water feature, whichever is less, subject to the following conditions:

1. The design engineer preparing the engineering plan shall determine an **approximate base flood elevation** and include a narrative describing his/her level of confidence in the approximate base flood elevation. The **narrative** must include, but is not limited to, an assessment of potential backwater effects (such as might result from nearby river flooding, for example); observations and/or anecdotal information on water surface elevations during previous flood events; and an assessment of potential for significantly higher future flows at basin build out. *Note: Many of these issues will have been addressed in a Level 1 downstream analysis, if required.* Acceptance of the approximate base flood elevation shall be at the sole discretion of the City. If the approximate base flood elevation is not acceptable, a Minor Floodplain Study or Major Floodplain/Floodway Study may be required.
2. That portion of the *site* that is at or below the assumed base flood elevation must be delineated and designated as a floodplain on the engineering plan, and a **notice on title** must be recorded for the *site*, notifying future property owners of the approximate floodplain and base flood elevation.

4.4.2.3 MINOR FLOODPLAIN STUDY

IF the proposed *project site* does not meet the conditions for “no floodplain study required” per Section 4.4.2.1 or for use of the Approximate Floodplain Study per Section 4.4.2.2, AND the *project site* is either on land that is outside of an already delineated Zone A floodplain (i.e., without base flood

⁷ *Engineering plan* means a site improvement plan, including supporting documentation, stamped by a **licensed civil engineer**. In some instances, **CED** review staff may determine that the proposed *project* is sufficiently above the clearances specified in this exception and may not require an engineering plan. Typically, this is done for **projects** in Simplified Drainage Review that clearly exceed minimum clearances and otherwise would not require engineering design.

elevations determined) or is adjacent to a water feature for which a floodplain has not been determined, THEN a Minor Floodplain Study may be used to determine the floodplain. However, if the Minor Floodplain Study determines that all or a portion of the *project site* is at or below the base flood elevation of a river or stream and thus within the floodplain, then the applicant must either redesign the *project site* to be out of the floodplain or complete a Major Floodplain/Floodway Study per Section 4.4.2.4.

Use of the Minor Floodplain Study requires submittal of an engineering plan and supporting calculations. That portion of the *site* that is at or below the determined base flood elevation must be delineated and designated as a floodplain on the engineering plan, and a **notice on title** must be recorded for the *site*, notifying future property owners of the floodplain and base flood elevation.

Methods of Analysis

For **streams** without a floodplain or flood hazard study, or for **drainage ditches or culvert headwaters**, the base flood elevation and extent of the floodplain shall be determined using the Direct Step backwater method, Standard Step backwater method, or the King County Backwater computer program, as described in Section 4.4.1.2.

For **lakes, wetlands, and closed depressions** without an approved floodplain or flood hazard study, the base flood elevation and the extent of the floodplain shall be determined using the “point of compliance technique” described in Section 3.3.6.

4.4.2.4 MAJOR FLOODPLAIN/FLOODWAY STUDY

The floodplain analysis shall be based on the 100-year storm event using existing land use hydrology except as noted in the paragraph titled “Flood Flows from Adopted Basin Plan Information.”

IF the proposed *project site* is on land that is partially or fully within an already delineated floodplain of a **river or stream**, or determined by a Minor Floodplain Study to be partially or fully within the floodplain of a river or stream, THEN a Major Floodplain/Floodway Study is required to determine the floodplain, floodway, and base flood elevation in accordance with the methods and procedures presented in this section. This information will be used by the City to evaluate the *project's* compliance with regulations for **development** or improvements within the floodplain.

Major Floodplain/Floodway Studies must conform to FEMA regulations described in Part 65 of 44 Code of Federal Regulations (CFR). In addition, the following information must be provided and procedures performed.

❑ INFORMATION REQUIRED

The applicant shall submit the following information for review of a floodplain/floodway analysis in addition to that required for the drainage plan of a proposed *project*. This analysis shall extend upstream and downstream a sufficient distance to adequately include all backwater conditions that may affect flooding at the *site* and all reaches that may be affected by alterations to the *site*.

Floodplain/Floodway Map

A Major Floodplain/Floodway Study requires submittal of five copies of a separate floodplain/floodway map **stamped by a licensed civil engineer** and a **professional land surveyor** registered in the State of Washington (for the base survey). The map must accurately locate any proposed **development** with respect to the floodplain and floodway, the channel of the stream, and existing **development** in the floodplain; it must also supply all pertinent information such as the nature of any proposed *project*, legal description of the property on which the *project* would be located, fill quantity, limits and elevation, the building floor elevations, flood-proofing measures, and any use of compensatory storage.

The map must show elevation contours at a minimum of 2-foot vertical intervals and shall comply with survey and map guidelines published in the FEMA publication *Guidelines and Specifications for Flood Hazard Mapping Partners*. The map must **show the following**:

- Existing elevations and ground contours;
- Locations, elevations and dimensions of existing **structures**, and fills;
- Size, location, elevation, and spatial arrangement of all proposed **structures**, fills and excavations, including proposed compensatory storage areas, with final grades on the **site**;
- Location and elevations of roadways, water supply lines, and sanitary sewer facilities, both existing and proposed.

Study Report

A Major Floodplain/Floodway Study also requires submittal of two copies of a study report, **stamped by a licensed civil engineer**, which must include calculations or any computer analysis input and output information as well as the following additional information:

1. Valley **cross sections** showing the channel of the river or stream, the floodplain adjoining each side of the channel, the computed FEMA floodway, the cross-sectional area to be occupied by any proposed **development**, and all historic high water information.
2. **Profiles** showing the bottom of the channel, the top of both left and right banks, and existing and proposed base flood water surfaces.
3. Plans and specifications for **flood-proofing** any **structures** and fills, construction areas, materials storage areas, water supply, and sanitary facilities within the floodplain.
4. Complete **printout** of input and output (including any error messages) for **HEC-RAS**. Liberal use of comments will assist in understanding model logic and prevent review delays.
5. One **ready-to-run digital copy** of the **HEC-RAS** input file used in the study. Data shall be submitted in an electronic format.
6. The applicant shall prepare a **written summary** describing the model development calibration, hydraulic analysis, and floodway delineation. The summary shall also include an explanation of modeling assumptions and any key uncertainties.

□ DETERMINING FLOOD FLOWS

The **three techniques** used to determine the flows used in the analysis depend on whether gage data is available or whether a basin plan has been adopted. The first technique is for basins in adopted basin plan areas. The second technique is used if a gage station exists on the stream. The third technique is used on ungaged catchments or those with an insufficient length of record. In all cases, the design engineer shall be responsible for assuring that the hydrologic methods used are technically reasonable and conservative, conform to the *Guidelines and Specifications for Flood Hazard Mapping Partners*, and are acceptable by FEMA.

Flood Flows from Adopted Basin Plan Information

For those areas where the City or King County has adopted a basin plan since 1986, flood flows may be determined using information from the adopted basin plan. The hydrologic model used in the basin plan shall be updated to include the latest changes in zoning, or any additional information regarding the basin that has been acquired since the adoption of the basin plan.

Flood Flows from Stream Gage Data

Flood flows from stream gage data may be determined using HEC-FFA, which uses the Log-Pearson Type III distribution method as described in *Guidelines for Determining Flood Flow Frequency*, Bulletin 17B of the Hydrology Committee, prepared by the Interagency Advisory Committee on Water Data (1982). Refer

to the FEMA *Guidelines and Specifications for Flood Hazard Mapping Partners* to verify the most current requirements. Use of HEC-FFA is subject to the following requirements:

1. This technique may be used only if data from a gage station in the basin is available for a period of at least ten years that is representative of the current basin conditions.
2. If the difference in the drainage area on the stream at the study location and the drainage area to a gage station on the stream at a different location in the same basin is less than or equal to 50 percent, the flow at the study location shall be determined by transferring the calculated flow at the gage to the study location using a drainage area ratio raised to the 0.86 power, as in the following equation:

$$Q_{SS} = Q_G (A_{SS}/A_G)^{0.86} \quad (4-11)$$

where Q_{SS} = estimated flow for the given return frequency on the stream at the study location
 Q_G = flow for the given return frequency on the stream at the gage location
 A_{SS} = drainage area tributary to the stream at the study location
 A_G = drainage area tributary to the stream at the gage location

3. If the difference in the drainage area at the study location and the drainage area at a gage station in the basin is more than 50 percent and a basin plan has not been prepared, a continuous model shall be used as described below to determine flood flows at the study location.
4. In all cases where dams or reservoirs, floodplain development, or land use upstream may have altered the storage capacity or runoff characteristics of the basin so as to affect the validity of this technique, a continuous model shall be used to determine flood flows at the study location.

Flood Flows from a Calibrated Continuous Model

Flood flows may be determined by utilizing a continuous flow simulation model such as HSPF. Where flood elevations or stream gage data are available, the model shall be calibrated; otherwise, regional parameters⁸ may be used.

□ DETERMINING FLOOD ELEVATIONS, PROFILES, AND FLOODWAYS

Reconnaissance

The applicant's design engineer is responsible for the collection of all existing data with regard to flooding in the study area. This shall include a literature search of all published reports in the study area and adjacent communities, and an information search to obtain all unpublished information on flooding in the immediate and adjacent areas from federal, state, and local units of government. This search shall include specific information on past flooding in the area, drainage **structures** such as bridges and culverts that affect flooding in the area, available topographic maps, available flood insurance rate maps, photographs of past flood events, and general flooding problems within the study area. A field reconnaissance shall be made by the applicant's design engineer to determine hydraulic conditions of the study area, including type and number of **structures**, locations of cross sections, and other parameters, including the roughness values necessary for the hydraulic analysis.

Base Data

Cross sections used in the hydraulic analysis shall be representative of current channel and floodplain conditions obtained by surveying. When cross-sections data is obtained from other studies, the data shall be confirmed to represent current channel and floodplain conditions, or new channel cross-section data shall be obtained by field survey. Topographic information obtained from aerial photographs may be used in combination with surveyed cross sections in the hydraulic analysis. The **elevation datum** of all

⁸ Dinacola, 1990. U.S.G.S., Characterization and Simulation of Rainfall-Runoff Relations for Headwater Basins in Western King and Snohomish Counties, Washington.

information used in the hydraulic analysis shall be specified. All information shall be referenced directly to **NAVD 1988** (and include local correlation to NGVD 1929) unless otherwise approved by the City. See Table 4.4.2.B for correlations of other datum to NAVD 1988.

Methodology

Flood profiles and floodway studies shall be calculated using the U.S. Army Corps of Engineers' HEC-RAS computer model (or subsequent revisions).

Floodway Determination

1. **Flood hazard areas** are identified by the Federal Insurance Administration in a scientific and engineering report entitled the Flood Insurance Study for the City of Renton, dated September 29, 1989, and any subsequent revision, with accompanying flood insurance maps which are hereby adopted by reference and declared to be a part of this Section. The flood insurance study is on file at the Public Works Department.

Previous Floodplain Studies

If differences exist between a study previously approved by the City and the applicant's design engineer's calculated hydraulic floodways or flood profiles, the design engineer shall provide justification and obtain City approval for these differences.

Zero-Rise Calculation

For a zero-rise analysis, the flow profile for the existing and proposed *site* conditions shall be computed and reported to the nearest 0.01 foot. A zero-rise analysis requires only comparisons of the computed water surface elevations and energy grade lines for the existing and proposed conditions. Such comparisons are independent of natural dynamics and are not limited by the accuracy of the model's absolute water surface predictions.

Adequacy of Hydraulic Model

At a minimum, the City considers the **following factors** when determining the adequacy of the hydraulic model and flow profiles for use in floodway analysis:

1. Cross section spacing
2. Differences in energy grade

Note: Significant differences in the energy grade from cross section to cross section are an indication that cross sections should be more closely spaced or that other inaccuracies exist in the hydraulic model.

1. Methods for analyzing the hydraulics of **structures** such as bridges and culverts
2. Lack of flow continuity
3. Use of a gradually-varied flow model

Note: In certain circumstances (such as weir flow over a levee or dike, flow through the spillway of a dam, or special applications of bridge flow), rapidly-varied flow techniques shall be used in combination with a gradually-varied flow model.

1. Manning's "n" values
2. Calibration of the hydraulic model with past flood events
3. Special applications. In some cases, HEC-RAS alone may not be sufficient for preparing the floodplain/floodway analysis. This may occur where sediment transport, two-dimensional flow, or other unique hydraulic circumstances affect the accuracy of the HEC-RAS hydraulic model. In these cases, the applicant shall obtain City approval of other methods proposed for estimating the water surface profiles.

TABLE 4.4.2.B DATUM CORRELATIONS
(for general reference use only, values are approximate)

Correlation From To	(Snoq. Valley) NAVD 1988*	KCAS	U.S. Engineers	City of Seattle	NGVD, USGS & USC & GS 1947	Seattle Area Tide Tables & Navigation Charts 1954 & Later
NAVD 1988* (Upper Snoqualmie Valley)	-	-3.58	3.44	-9.54	-3.49	2.98
KCAS	3.58	-	7.02	-5.96	0.09	6.56
U.S. Engineers	-3.22	-7.02	-	-12.98	-6.93	-0.46
City of Seattle	9.54	5.96	12.98	-	6.05	12.52
NGVD, USGS & USC& GS 1947 (adjusted to the 1929 datum)	3.49	-0.09	6.93	-6.05	-	6.47
Seattle Area Tide Tables & Navigation Charts 1954 & Later (based on epoch 1924-1942)	-2.98	-6.56	0.46	-12.52	-6.47	-
Design Tidal Tailwater Elevation	12.08	8.50	15.52	2.54	8.59	15.06
Mean Higher High Water (MHHW)	8.34	4.76	11.78	-1.20	4.85	11.32
Mean High Water (MHW)	7.49	3.91	10.93	-2.05	4.00	10.47
Mean Low Water (MLW)	-0.16	-3.74	3.28	-9.70	-3.65	2.82
Mean Lower Low Water (MLLW)	-2.98	-6.56	0.46	-12.52	-6.47	0.00
<p>* <i>Varies, contact the City of Renton for datum correlation for this and other areas.</i> KCAS datum = Sea Level Datum 1929 (a.k.a. NGVD 1929) KCAS = King County Aerial Survey NAVD = North American Vertical Datum NGVD = National Geodetic Vertical Datum USGS = United States Geologic Survey USC & GS = US Coast and Geodetic Survey</p>						

(This page intentionally left blank.)